



NMEA 2000 Wi-Fi Gateway

WGX-1-ISO

User Manual

European Union

The full text of the EU declaration of conformity is available at the following internet address:

https://www.actisense.com/acti_download/wgx-1-declaration-of-conformity/

Hereby, Active Research Ltd declares that the WGX-1-ISO is in compliance with the essential requirements and other relevant provisions of Directive 2014/53/EU.

Active Research Ltd tímto prohlašuje, že tento WGX-1-ISO je ve shodě se základními požadavky a dalšími příslušnými ustanoveními směrnice 2014/53/EU.

Undertegnede, Active Research Ltd erklærer herved, at følgende udstyr WGX-1-ISO overholder de væsentlige krav og øvrige relevante krav i direktiv 2014/53/EU.

Hiermit erklärt, Active Research Ltd dass sich das Gerät WGX-1-ISO in Übereinstimmung mit den grundlegenden Anforderungen und den übrigen einschlägigen Bestimmungen der Richtlinie 2014/53/EU befindet.

Käesolevaga kinnitab, Active Research Ltd seadme WGX-1-ISO vastavust direktiivi 2014/53/EL põhinõuetele ja nimetatud direktiivist tulenevatele teistele asjakohastele sätetele.

Por medio de la presente Active Research Ltd declara que el WGX-1-ISO cumple con los requisitos esenciales y cualesquiera otras disposiciones aplicables o exigibles de la Directiva 2014/53/UE.

ΜΕ ΤΗΝ ΠΑΡΟΥΣΑ, Active Research Ltd ΔΗΛΩΝΕΙ ΟΤΙ WGX-1-ISO ΣΥΜΜΟΡΦΩΝΕΤΑΙ ΠΡΟΣ ΤΙΣ ΟΥΣΙΩΔΕΙΣ ΑΠΑΙΤΗΣΕΙΣ ΚΑΙ ΤΙΣ ΛΟΙΠΕΣ ΣΧΕΤΙΚΕΣ ΔΙΑΤΑΞΕΙΣ ΤΗΣ ΟΔΗΓΙΑΣ 2014/53/ΕΕ.

Par la présente, Active Research Ltd déclare que l'appareil WGX-1-ISO est conforme aux exigences essentielles et aux autres dispositions pertinentes de la directive 2014/53/UE.

Con la presente, Active Research Ltd dichiara che questo WGX-1-ISO è conforme ai requisiti essenziali ed alle altre disposizioni pertinenti stabilite dalla direttiva 2014/53/UE.

Ar šo Active Research Ltd deklarē, ka WGX-1-ISO atbilst Direktīvas 2014/53/ES būtiskajām prasībām un citiem ar to saistītajiem noteikumiem.

Šiuo Active Research Ltd deklaruoja, kad šis WGX-1-ISO atitinka esminius reikalavimus ir kitas 2014/53/ES Direktyvos nuostatas.

Hierbij verklaart , Active Research Ltd dat het toestel WGX-1-ISO in overeenstemming is met de essentiële eisen en de andere relevante bepalingen van richtlijn 2014/53/EU.

Hawnhekk, Active Research Ltd, jiddikjara li dan WGX-1-ISO jikkonforma mal-ftigijiet essenzjali u ma provvedimenti oħrajn relevanti li hemm fid-Direttiva 2014/53/UE.

Alulírott, Active Research Ltd nyilatkozom, hogy a WGX-1-ISO megfelel a vonatkozó alapvető követelményeknek és az 2014/53/EU irányelv egyéb előírásainak.

Niniejszym Active Research Ltd oświadcza, że WGX-1-ISO jest zgodny z zasadniczymi wymogami oraz pozostałymi stosownymi postanowieniami Dyrektywy 2014/53/UE.

Active Research Ltd declara que este WGX-1-ISO está conforme com os requisitos essenciais e outras disposições da Directiva 2014/53/ UE.

Active Research Ltd izjavlja, da je ta WGX-1-ISO v skladu z bistvenimi zahtevami in ostalimi relevantnimi določili direktive 2014/53/EU.

Active Research Ltd tímto vyhlasuje, že WGX-1-ISO spĺňa základné požiadavky a všetky príslušné ustanovenia Smernice 2014/53/EÚ.

Active Research Ltd vakuuttaa täten että WGX-1-ISO tyyppinen laite on direktiivin 2014/53/EU oleellisten vaatimusten ja sitä koskevien direktiivin muiden ehtojen mukainen.

Härmed intygar Active Research Ltd att denna WGX-1-ISO står i överensstämmelse med de väsentliga egenskapskrav och övriga relevanta bestämmelser som framgår av direktiv 2014/53/EU.

Hér með lýsir Active Research Ltd yfir því að WGX-1-ISO er í samræmi við grunnkröfur og aðrar kröfur, sem gerðar eru í tilskipun 2014/53/ EU.

Active Research Ltd erklærer herved at utstyret WGX-1-ISO er i samsvar med de grunnleggende krav og øvrige relevante krav i direktiv 2014/53/EU.

Noi, Active Research Ltd, declarăm pe propria noastră răspundere că produsul WGX-1-ISO este în conformitate cu cerințele esențiale și celelalte prevederi aplicabile ale Directivei 2014/53/UE.

Contents

European Union.....	2	Data Server Settings.....	20
Important Notices.....	4	Serial Settings	21
Trademarks and Registered Trademarks.....	4	Filtering.....	22
Fair Use Statement	4	Administration Settings	27
Technical Accuracy.....	4	Firmware Update Page	28
Product Registration	4	Actisense-i.....	29
Product Guarantee	4	LED Operation and Indication Trouble Shooting Guide	31
Product Disposal.....	4	Technical Support and the Returns Procedure	32
Installation Warnings.....	5	Inserting a micro SD card.....	32
Regulatory & Safety Notices	6	Password Recovery	33
USA: Federal Communications Commission (FCC) Statement	6	Firmware Update.....	34
FCC Warning.....	6	Firmware Update from WebApp via Wi-Fi	34
Canada: Industry Canada (IC) Statement.....	6	Firmware Update using Actisense Toolkit	34
WGX-1-ISO Introduction & Features.....	7	Firmware Update using micro SD card	35
NMEA 2000 Network Basics	8	Mounting the WGX-1-ISO	35
Minimum Requirements.....	8	Bulkhead Mounting	35
WGX-1-ISO Connectivity	9	Technical Specification.....	36
Powering the WGX-1-ISO.....	9	Product Dimensions (mm).....	37
Windows Port Number Configuration	10		
Connecting to a WGX-1-ISO.....	10		
Connecting to a Raymarine SeaTalkNG Network...13			
Connecting an WGX-1-ISO to an NMEA 0183 device	13		
Autobaud	13		
WGX-1-ISO Wi-Fi Set Up	14		
Connecting to Wi-Fi	14		
Wi-Fi Modes.....	14		
Access Point Method	14		
Client Method	14		
Configuring the WGX-1-ISO	15		
Information Page	15		
Settings Menu Page	16		
Login Page	16		
Wi-Fi Access Point Setting.....	17		
Wi-Fi Client Settings.....	18		
Operating Mode Settings.....	19		

Important Notices

The device to which this manual relates complies with the Electromagnetic Compatibility requirements according to IEC 60945:2002-08, DNVGL-CG-0339:2019 & IACS UR E10 Rev7. The unit should always be used in conjunction with appropriately approved, shielded cable and connectors as per NMEA 0400 to ensure compliance.

If the device to which this manual relates is to be installed within five metres of a compass, please refer to the 'Compass Safe Distance' section in the 'Technical Specifications' table.

Trademarks and Registered Trademarks

Actisense® and the Actisense logo are registered trademarks of Active Research Limited (Ltd). All other trademarks are the property of their respective owners.

The NMEA® name and NMEA logo are copyright held by the NMEA. All uses in this manual are by permission and no claim on the right to the NMEA name or logo are made in this manual.

Fair Use Statement

The contents of this manual may not be transferred or copied without the express written permission of Active Research Ltd. Copyright© 2024 Active Research Ltd. All rights reserved.

Technical Accuracy

To the best of our knowledge the information contained in this document was correct at the time it was produced. Active Research Ltd cannot accept liability for any inaccuracies or omissions. The products described in this manual and the specifications thereof may be changed without prior notice. Active Research Ltd cannot accept any liability for differences between the product and this document. To check for updated information and specifications please check www.actisense.com.

Active Research Ltd will not be liable for infringement of copyright, industrial property rights, or other rights

of a third party caused by the use of information or drawings described in this manual.

Product Registration

Please register your product via the online form at <https://actisense.com/product-registration>

Your product package includes a unit serial number. The serial number is six digits long and can be found below the barcode on the label. Your registration will assist Actisense Support to link your product to your details, simplifying any future assistance you may require.

Product Guarantee

All Actisense products are provided with a 5 year guarantee upon product registration. To register your product, visit <https://actisense.com/product-registration>

If you suspect that the unit is faulty please refer to the Troubleshooting Section of the User Manual before contacting support.

It is a requirement of the guarantee that all installations of electronic equipment follow the NMEA 0400 specification. Any connection to a battery or power supply must meet the mandatory essential safety requirements that may be imposed by local regulatory agencies.

Actisense products are intended for use in a marine environment, primarily for below deck use. If a product is to be used in a more severe environment, such use may be considered misuse under the Active Research Ltd guarantee.

Product Disposal

Please dispose of this product in accordance with the WEEE Directive. The product should be taken to a registered establishment for the disposal of electronic equipment. The product packaging is recyclable.

Note: All features and specifications may change without notice.

Installation Warnings

All warnings and notices must be followed to ensure the correct operation of the WGX-1-ISO. Incorrect installation may invalidate the guarantee.

It is highly recommended that all of the installation instructions are read before commencing the installation. There are important warnings and notes throughout the manual that should be considered before the installation is attempted.

Warning 1: Installation and Operation

This product must be installed and operated in accordance with the instructions provided. Failure to do so could result in personal injury, damage to your boat and/or poor product performance. The WGX-1-ISO should only be used as an aid to vessel monitoring, control or navigation and should not be used as a replacement for traditional aids and techniques.

Warning 2: Installation Code of Practice

When wiring the power supply to the WGX-1-ISO ensure the isolation switch is off. Wiring the WGX-1-ISO while the connection is live may damage the device and is in breach of the guarantee. Any connection to a battery or power supply must meet the mandatory essential safety requirements that may be imposed by local regulatory agencies, this should include suitable fusing.

All wiring should be in accordance with the requirements of the NMEA 0400 installation specification.

Warning 3: Mounting Requirements

Select a flat location to mount the WGX-1-ISO. Mounting on a contoured surface may cause damage to the case. Do not mount the device while it is powered, or the cables are connected. See also "Mounting the WGX-1-ISO" section.

Do not mount the WGX-1-ISO in the same plane as transmitting or receiving antennas.

Do not mount the WGX-1-ISO close to an electronic compass. If the device to which this manual relates is to be installed within five metres of a compass, please refer to the 'Compass Safe Distance' section in the technical specifications at the end of this manual.

This device should not be operated within 20cm of a human body.

To avoid potential injury, it should be mounted at a height of less than 2m from floor level.

Warning 4: Safe Distance

This device should be installed and operated keeping a distance of at least 20cm between it and a persons body.

Radio Transceiver:

The WGX-1-ISO contains a Wi-Fi / BT Radio Transceiver operating in the 2400 – 2484 MHz band with a maximum transmit power of 84mW.

Software Updates

The WGX-1-ISO unit has built-in firmware which is held in flash memory, allowing quick and easy upgrades using the firmware update option on the web interface. It is highly recommended that the devices firmware is kept up to date.

Details of the latest WGX-1-ISO firmware version released can be viewed at www.actisense.com

Regulatory & Safety Notices

USA: Federal Communications Commission (FCC) Statement

This device complies with FCC part 15 FCC Rules. Operation is subject to the following two conditions:

1. This device may not cause harmful interference.
2. This device must accept any interference, including interference that may cause undesired operation of the device.

FCC Warning

Changes or modifications not expressly approved by the party responsible for compliance could void the user's authority to operate the equipment.

NOTE: This equipment has been tested and found to comply with the limits for a Class B digital device, pursuant to part 15 of the FCC Rules. These limits are designed to provide reasonable protection against harmful interference in a residential installation. This equipment generates, uses and can radiate radio frequency energy and, if not installed and used in accordance with the instructions, may cause harmful interference to radio communications. However, there is no guarantee that interference will not occur in a particular installation. If this equipment does cause harmful interference to radio or television reception, which can be determined by turning the equipment off and on, the user is encouraged to try to correct the interference by one or more of the following measures:

- Reorient or relocate the receiving antenna.
- Increase the separation between the equipment and receiver.
- Connect the equipment into an outlet on a circuit different from that to which the receiver is connected.
- Consult the dealer or an experienced radio/TV technician for help.

This device meets the FCC and IC requirements for RF exposure in public or uncontrolled environments.

Canada: Industry Canada (IC) Statement

IC Notice to Users English/French in accordance with RSS GEN Issue 3:

This device complies with Industry Canada license exempt RSS standard(s).

Operation is subject to the following two conditions:

1. this device may not cause interference, and
2. this device must accept any interference, including interference that may cause undesired operation of the device.

Cet appareil est conforme avec Industrie Canada RSS standard exempts de licence (s). Son utilisation est soumise à Les deux conditions suivantes:

1. cet appareil ne peut pas provoquer d'interférences et
2. cet appareil doit accepter Toute interférence, y compris les interférences qui peuvent causer un mauvais fonctionnement du dispositif

This Class B digital apparatus complies with Canadian ICES-003.

Cet appareil numérique de la classe B est conforme à la norme NMB-003 du Canada

Introduction & Features

The **WGX-1-ISO** is a **Multi-function NMEA2000 Gateway**, providing **Wi-Fi streaming, NMEA data conversion, data logging functionality and includes an ISO (serial / NMEA 0183) port.**

The **WGX-1-ISO** is a **powerful routing device** allowing advanced routing of data between the NMEA 2000 network, its ISO (serial / NMEA 0183) port and its 3 separate Wi-Fi data servers.

NMEA 2000 data can be converted to a number of useful formats including NMEA 0183, N2K ASCII and N2K Actisense (proprietary formats) as well as NGT Actisense format (compatible with our NGT/NGX products). Converting NMEA 0183 data to NMEA 2000 (and vice versa), allows sharing of information between devices from the two standards and the WGX-1-ISO provides all the features of the popular legacy NGW-1.

It provides an easy way to link a PC to a NMEA 2000 network and also provides all the features of the popular legacy NGT-1 allowing NMEA 2000 data to be transferred from an NMEA 2000 backbone to any compatible device (e.g. laptop, tablet or smartphone) connected to it via the serial port or via Wi-Fi.

It's Wi-Fi data server functionality allows a variety of vessel data (e.g. position, speed, course, wind speed, depth, engine data, AIS messages etc.) to be shared with NMEA 0183 compatible software applications running on connected devices.

It also provides high speed data logging to a micro SD card (not supplied) which can be used for voyage data logging and analysis.

It has the built in Actisense-I network health checker which provides valuable network diagnostics.

The WGX-1-ISO has the legendary Actisense "Reliability Built In" along with useful diagnostic LEDs, internal antenna, enhanced password security, full certification and all packaged in an extremely rugged IP67 case.

Main features:

- Multi-function Gateway:
 - Bi-directional conversion between NMEA 2000 and NMEA 0183.
 - Wi-Fi streaming via 3 separate data servers.
 - Transfer NMEA 2000 to connected devices.
 - Data logging for voyage data recording to SD card (micro SD card not supplied).
- Works as an access point and also connects to existing Wi-Fi networks in client mode.
- Award winning ISO-Drive™ technology provides safe and secure interconnectivity.
- Actisense-i¹ network health checker provides valuable diagnostics.
- Fully configurable over Wi-Fi using built in Webapp.
- Advanced routing and filtering capability.
- Compatible with RS-422, RS-232 & RS-485 (unidirectional) up to 230K baud.
- Rugged water resistant IP67 enclosure.
- Powered from NMEA 2000 bus.
- Multiple diagnostic LED's provide valuable feedback.
- Can be used to configure and update other Actisense NMEA 2000 devices.
- Firmware is upgradeable, ensuring device is futureproof.
- Raymarine SeaTalk^{ng} adapter cable available as an accessory.

¹Actisense-I is a developing feature, with more capability to be added in future updates

NMEA 2000 Network Basics

Minimum Requirements

A correctly powered and terminated NMEA 2000 network is required before installing the WGX-1-ISO. The minimum requirement for any NMEA 2000 network is :

Either

- An **Actisense SBN-1/2** (a NMEA 2000 self-contained network)

Or

- Power insertion point, or 'Power T' (**Actisense A2K-MPT-2**)
- 2x T-Pieces (**Actisense A2K-T-MFF**)
- 2x Termination resistors. One at either end of the NMEA 2000 Network (**Actisense A2K-TER**)

And

- 2x NMEA 2000 Devices (The WGX-1-ISO is one of these devices shown below)

NMEA 2000 Network Cable Limitations

Cable Type	Max Length	Max Amp	Power Pair	Data Pair
Drop Cable	6m			
Sum of all drop cables	78m			
Micro backbone (terminator to terminator)	100m	3 Amps	22 AWG	24 AWG
Mid backbone (terminator to terminator)	250m	4 Amps	16 AWG	20 AWG
Mini backbone (terminator to terminator)	250m	8 Amps	15 AWG	18 AWG

Minimum NMEA 2000[®] Micro Cable Network (2 devices)

Note: Maximum backbone length cannot exceed 100 metres

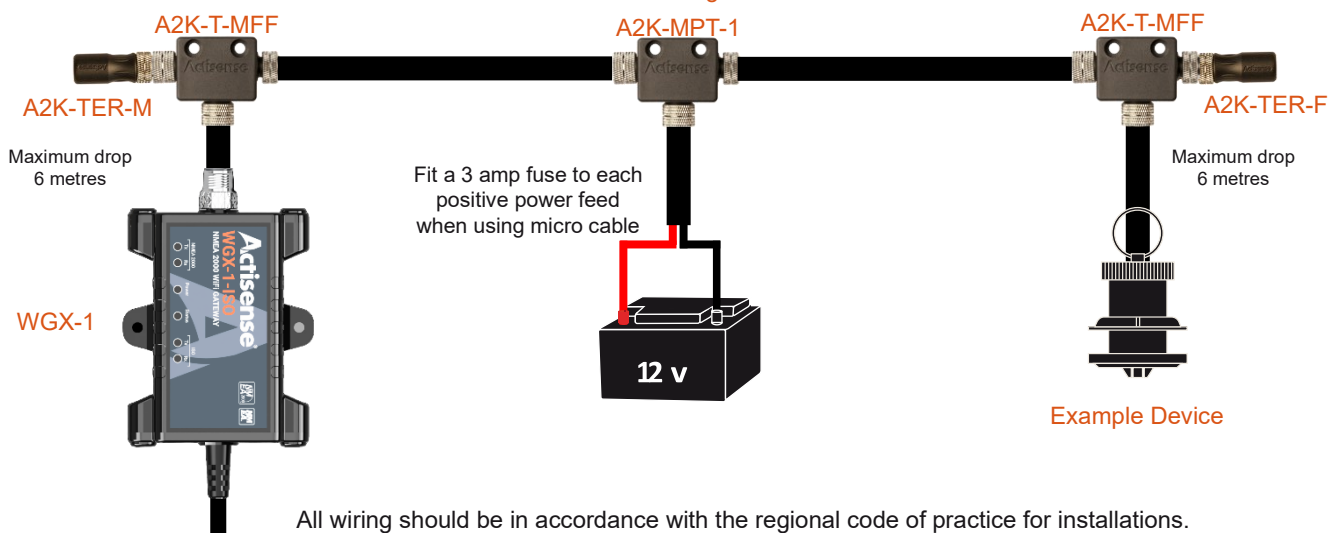

All wiring should be in accordance with the regional code of practice for installations.

WGX-1-ISO Connectivity

The diagram below shows where the WGX-1-ISO sits in terms of connectivity with other devices on your vessel.

- The WGX-1-ISO, being an NMEA 2000 device will “T” into your bus in common with any other NMEA 2000 device that you might fit to your network. It can either be connected directly to a “T” piece or attached to the bus using a suitably long trunk-drop cable of no more than 6m in length.
- The ISO cable attached to the WGX-1-ISO is used to connect to an NMEA 0183 device or serial port on a PC.
- The WGX-1-ISO is capable of operating as an NMEA 2000 gateway, providing access to NMEA 2000 messages, in a similar way to the NGT-1-ISO.
- The WGX-1-ISO is also capable of operating as an NMEA 2000 - NMEA 0183 bi-directional converter translating NMEA 2000 messages into NMEA 0183 sentences and vice-versa, in a similar way to the NGW-1-ISO.
- The WGX-1-ISO also incorporates a Wi-Fi module allowing data streaming to Wi-Fi enabled devices such as PC’s, tablets and smart phones. Suitable 3rd-party marine software will need to be installed on your devices to take advantage of data output either over USB or Wi-Fi.

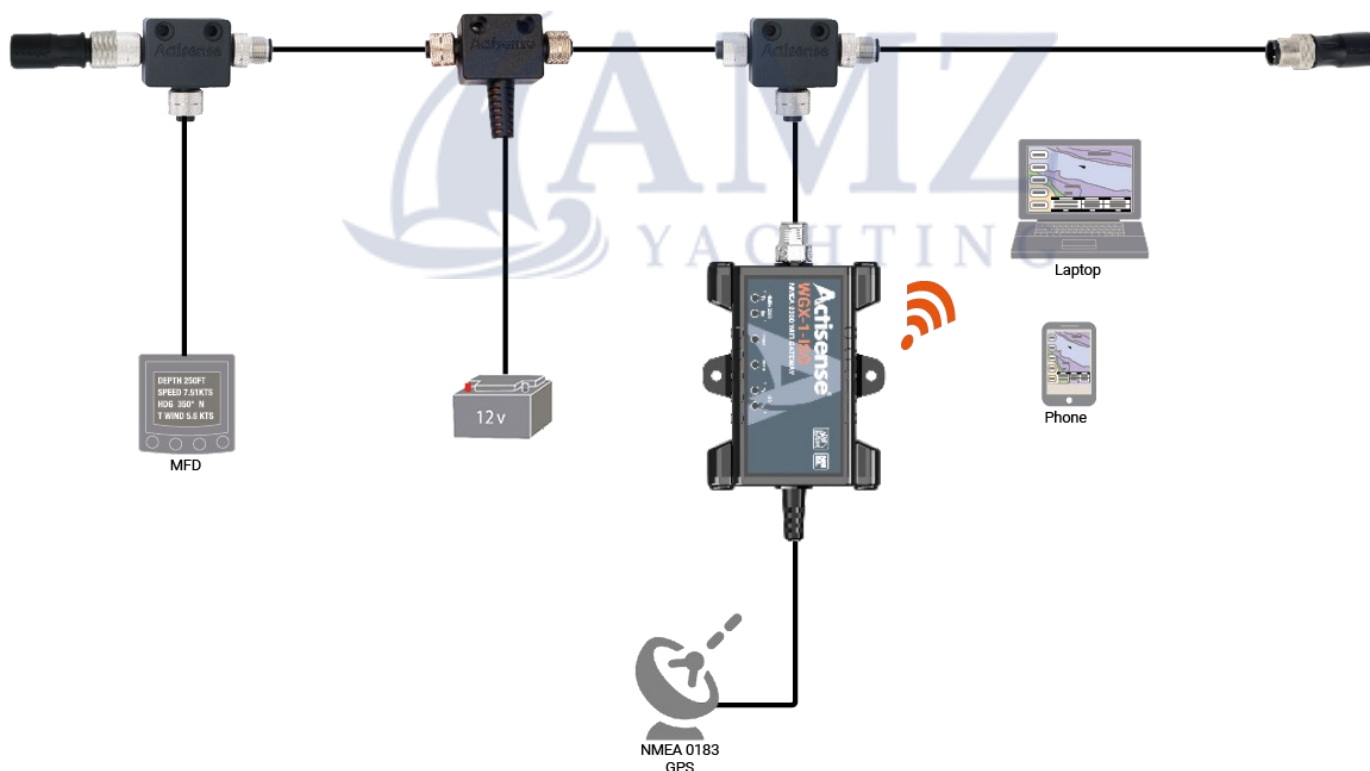

Powering the WGX-1-ISO

The WGX-1-ISO receives its power from the NMEA 2000 backbone. Please refer to the technical specifications page for details regarding the LEN. Once powered, the Blue “Power” LED inside the case will illuminate. Refer to the ‘Troubleshooting’ section of this manual for a full description of the WGX-1-ISO LED behaviour.

Windows Port Number Configuration

When using a USB to serial converter cable (on the ISO cable) you will see the name of the converter cable with no reference to the WGX-1-ISO. If you have connected to an RS232 port on the PC this will be listed as a 'Communications Port', again with no reference to the WGX-1-ISO. To change this number, double click the port and select the 'Port Settings' tab. Click the 'Advanced' button and change the port number to the one required.

Connecting to a WGX-1-ISO





There are several ways which the WGX-1-ISO can be connected, but the most common requirement will be to integrate an NMEA 0183 device to an NMEA 2000 network.

The WGX-1-ISO communicates on its ISO port using the RS-422 protocol which requires that data is sent and received using two pairs of wires. These are often termed as a "differential" pair.

The two pairs of wires are normally designated as:

- **Talker pair (A+ / B-):** This is the pair over which data is sent from the WGX-1-ISO.
- **Listener Pair (A+ / B-):** This is the pair over which the WGX-1-ISO receives NMEA 0183 data.

The specified NMEA 0183 signal colour coding for individual wires is as follows:

- Talker (A/+) -WHITE 
- Talker (B/-) - BROWN 
- Listener (A/+) - YELLOW 
- Listener (B/-) – GREEN 

The wiring on the WGX-1-ISO follows the above convention for the data pairs, and if followed, should make wiring NMEA 0183 devices which have the same colour coding easier to achieve. Please refer to the instructions of the device which you are connecting to your WGX-1-ISO for more details. The following diagrams show how to connect to the most popular devices to a WGX-1-ISO:

A - Connect to an NMEA 0183 Device

Connect the WGX-1-ISO as shown in the diagram overleaf. If the device conforms to the NMEA 0183 standard, it should have the appropriate talker (A/+ & B/-) and listener (A/+ & B/-) pair clearly marked. Consult the manual or contact the manufacturer if unsure.

B - Connect to a PC with an Actisense USG-2. USB to Serial Gateway (RS-422)

Should you require to connect your WGX-1-ISO to a PC, you can attach an RS-422-Serial converter such as the Actisense USG-2. <https://actisense.com/products/usg-2-nmea-0183-converter/>

Note: To communicate with your WGX-1-ISO, select the USG-2 COM port displayed in "Device Manager"

C - Connect to a PC using and RS-232 Serial to USB converter

The WGX-1-ISO can also be connected to an RS-232 Serial converter if required. There are many such devices available and the diagram depicts a standard general outline only. The two B/- wires are connected together at a common ground.

Note: To communicate with your NGX-1, select the corresponding COM port for the converter in “Device Manager”

D- Connect to a serial port using a D-TYPE 9-pin socket

The WGX-1-ISO can also be connected to the older D-type 9 pin serial port should you wish to connect it directly into a serial port card on your PC. The serial connection is RS-232 and the two B/- wires are connected together at a common ground (pin 5).



Connecting to an WGX-1-ISO (contd)

A

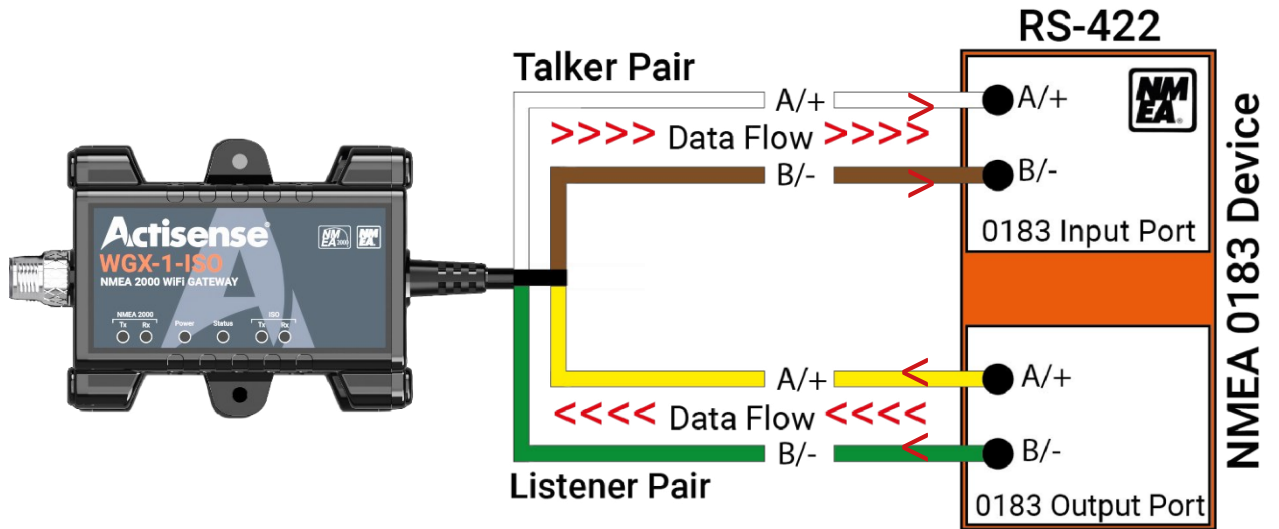

B

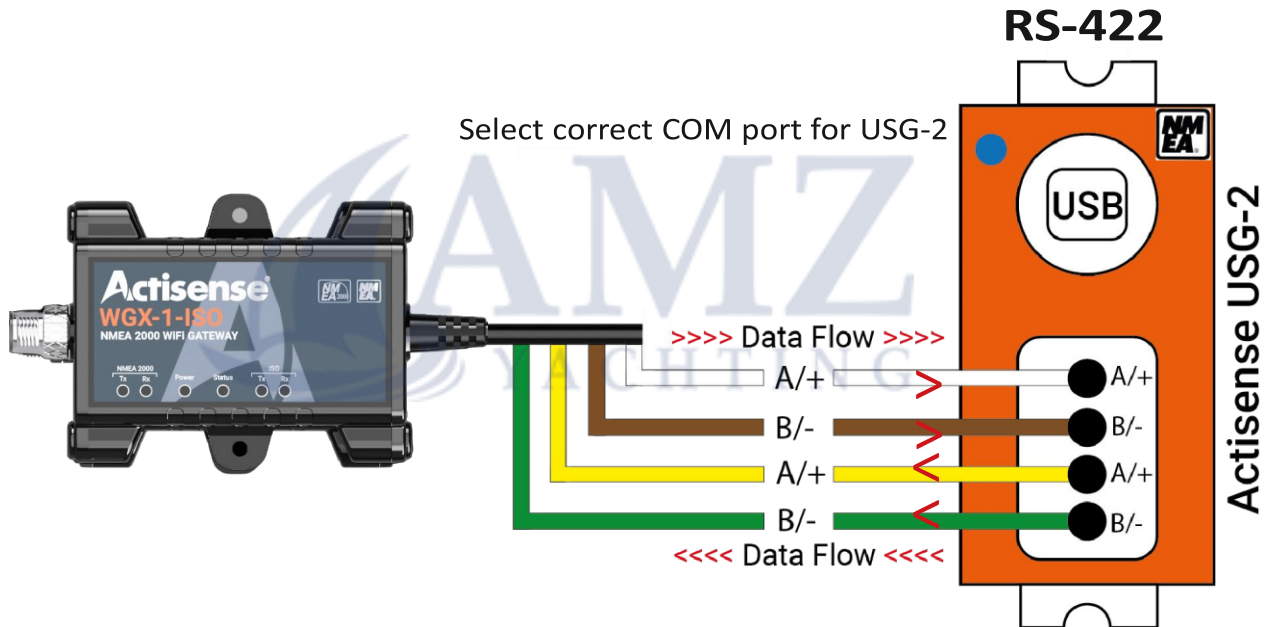

C

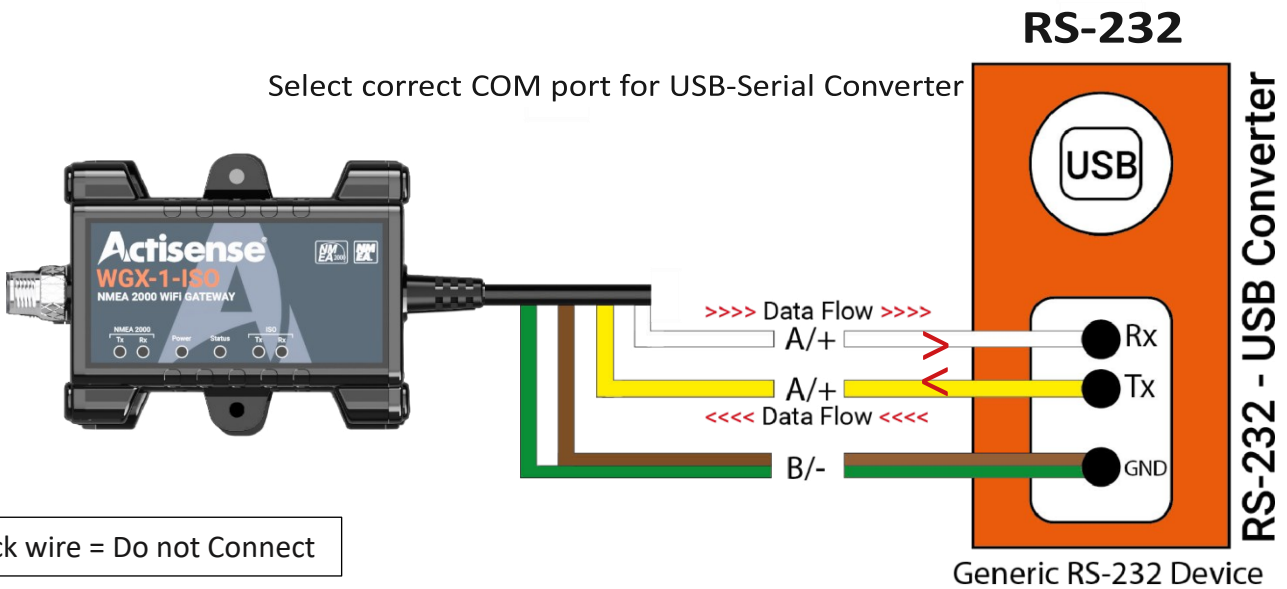

Note: Black wire = Do not Connect

Connecting to an WGX-1-ISO (contd)

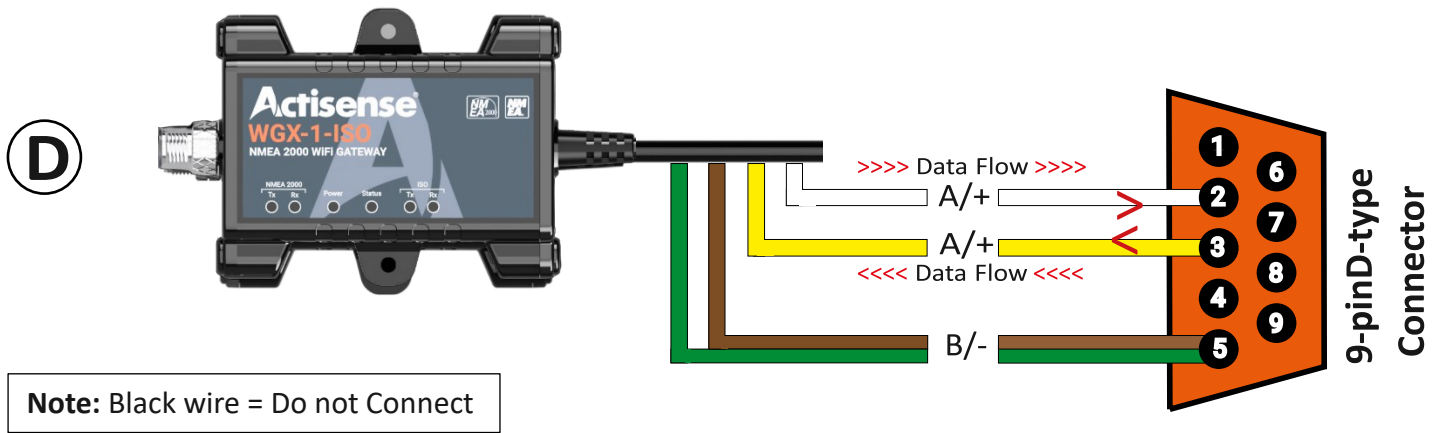

Connecting to a Raymarine SeaTalkNG Network

Raymarine’s SeaTalk^{NG} network uses exactly the same data as a standard NMEA 2000 network. The only difference is the physical network connections. To connect any standard NMEA 2000 device (like the NGX-1) to an STNG network, simply use an NMEA 2000 to STNG adapter cable (product code: STNG-A06045) between the device and the STNG network.

Connecting an WGX-1-ISO to an NMEA 0183 device

The WGX-1-ISO is shipped with a default configuration to allow for an easy set-up when installing to devices running at either of the two common baud rates (4,800 or 38,400).

The default mode is set to ‘Convert’ and the default baud rate is set to 4,800 allowing devices outputting at this speed to be installed quickly.

Autobaud

Auto baud is a feature which allows the WGX-1-ISO to automatically detect the rate of the incoming data and adjust itself accordingly. For example, connection to an NMEA 0183 talker outputting data at 38,400 baud will force the WGX-1-ISO (after a delay of approximately 15 seconds) to accept data at that speed. As mentioned above, the device accepts data at 4,800 baud by default in “Convert” mode.

The WGX-1-ISO will auto-baud to any baud rate between 4,800 and 230,400 baud. This allows the WGX-1-ISO to automatically adjust to any commonly used baud rates without the need for any further configuration.

In Transfer mode the WGX-1-ISO will use 115,200 by default but will autobaud to 230,400 to allow ‘Transfer’ of all PGN’s even on a busy NMEA 2000 bus.

The baud rate can be manually changed using the embedded WebApp (see **Serial Settings** below) or else by using Actisense Toolkit or NMEA Reader software. The WGX-1-ISO will remember the last used baud rate for each mode.

WGX-1-ISO Wi-Fi Set Up

The WGX-1-ISO has a built in, web based configuration tool compatible with the latest versions of all popular web browsers. To access it, a Wi-Fi connection is required between a compatible device and the WGX-1-ISO.

Connecting to Wi-Fi

The initial connection to a WGX-1-ISO must use the Access Point Method, and it will broadcast it's **SSID** as "**wgx-<serial number>**". This ensures that, by default, every WGX-1-ISO has a unique Access Point name.

The serial number of your device can be found printed on the label on the rear of the case. (e.g. If your serial number is 123456, then your the SSID for your WGX-1-ISO will be WGX-123456) The default Wi-Fi password is printed on the rear of the device. (**Note:** this is unique for every WGX-1-ISO)

Note: the password is 8 characters consisting of 1...9, A...Z (excluding I & O), a...z (excluding l) A spare password sticker is also provided which can be kept in a safe & convenient location to avoid having to physically access the WGX-1-ISO. (e.g. if more devices need to be connected to the WGX-1-ISO)

This Wi-Fi password can be changed at any time, but if it's lost or forgotten, the WGX-1-ISO password can be reset back to its default after gaining physical access to the unit, see Password Recovery.

The WGX-1-ISO's SSID will be visible using the network settings (show available networks) of your PC, or usually under settings / connections / Wi-Fi on your mobile device. Selecting it will prompt a connection and request the user to enter the Wi-Fi password listed on the rear of the device. Once the password is entered, the Wi-Fi enabled PC or device should connect within a few seconds. (dependant on operating system)

Note: The connection manager will report "No Internet" which is correct as your device is now connected directly to the WGX-1-ISO Access Point which does not provide internet access.

The WGX-1-ISO's built-in configuration can always be accessed by typing in the **IP address:192.168.4.1** into the address bar of your Wi-Fi enabled PC or devices web browser.

Wi-Fi Modes

The WGX-1-ISO can be used in either Access Point Method or Client Method (also referred to as Station or STA mode). Both modes can also be used simultaneously.

Access Point Method

This method can also be used where other Wi-Fi devices need to connect to / exchange data with the WGX-1-ISO in the absence of an existing Wi-Fi network. The WGX-1-ISO will, by default, use channel 1 in this mode.

Client Method

This is where the WGX-1-ISO will become a "client" on an existing Wi-Fi enabled network, enabling the WGX-1-ISO to connect to / exchange data with other devices connected to that existing network. The WGX-1-ISO will switch to the Wi-Fi channel of the client network in this mode. See Wi-Fi Client settings.

The WGX-1-ISO default channel for access point mode is channel 1, however when the WGX-1-ISO is used in client mode, the Wi-Fi channel of the client (e.g. Wi-Fi router) will be adopted by the WGX-1-ISO for all modes. The device which is browsing will need to re-connect to the access point or connect via the client using the client IP address. The WGX-1-ISO remembers client status, so even on a power cycle it will then automatically join the client on its channel.

Configuring the WGX-1-ISO

Make sure you have connected the WGX-1-ISO Access Point via Wi-Fi with your PC or device. You can now access the WGX-1-ISO configuration page from any web browser. Enter the **IP address : 192.168.4.1** into the address bar and you will be presented with the WGX-1-ISO home page.

Note: Pages which allow configuration changes are password protected and will prompt the user to “Login”.

Note: The web browser will automatically test its connection to the WGX-1-ISO and display a warning if the connection is lost.



Information Page

Use this page to access important product information such as device status, serial number, MAC address and firmware version. Client and access point status are also available from this page.

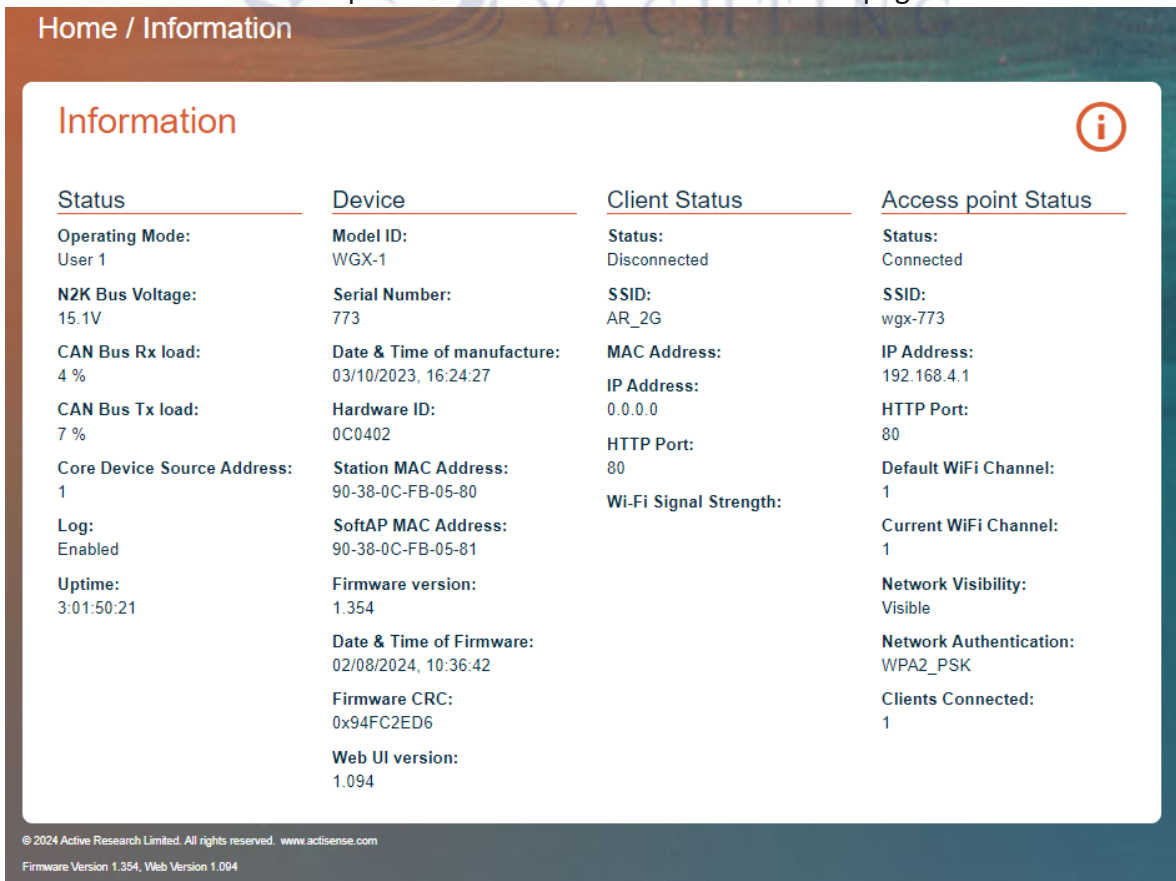

Settings Menu Page

All the system configuration can be done via the Settings page.

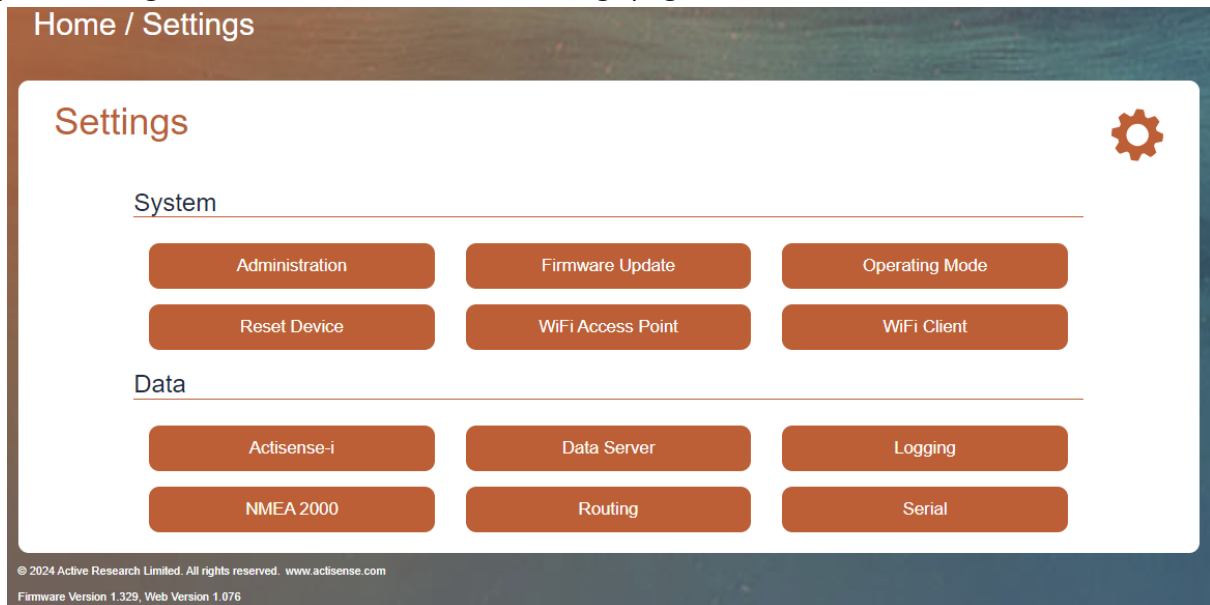

Login Page

The default login details to access the WGX-1-ISO configuration are:

Username : **admin** Password : **default admin password (printed on the rear of the unit)**

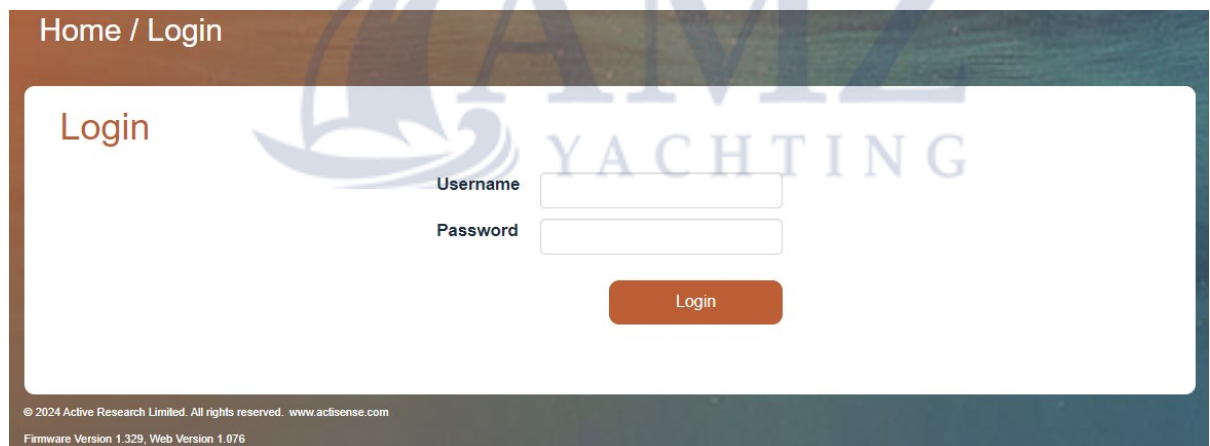

Note: Each device has a unique default admin password which can be changed by the user. Resetting to defaults (after gaining physical access to the unit) will reset this password back to the default printed on the rear of the unit.

In order to change any of the devices configuration settings the user will be prompted to login and enter the credentials.

See Administration for further details on changing password. (it is recommended this password is changed for enhanced security)

Wi-Fi Access Point Setting

The Wi-Fi Password can be changed here. It needs to be a minimum of 8 characters, and a max of 50.

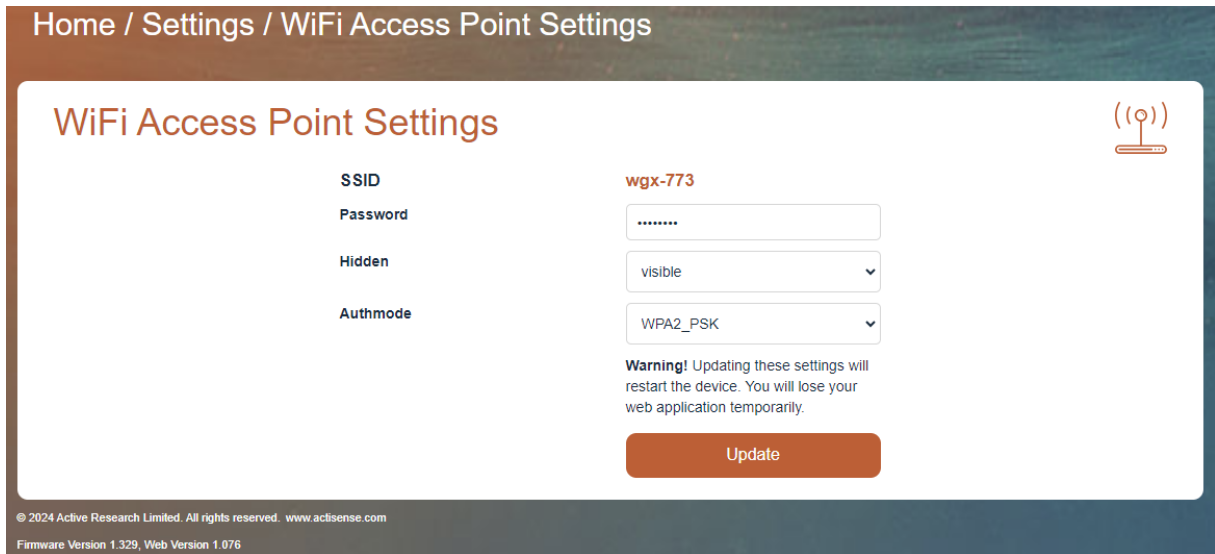

The screenshot shows the 'WiFi Access Point Settings' page. At the top, there is a breadcrumb trail: 'Home / Settings / WiFi Access Point Settings'. The main heading is 'WiFi Access Point Settings' with a Wi-Fi icon on the right. The settings are as follows:

SSID	wgx-773
Password
Hidden	visible
Authmode	WPA2_PSK

Below the settings, there is a warning: 'Warning! Updating these settings will restart the device. You will lose your web application temporarily.' and an 'Update' button.

At the bottom left, there is a footer: '© 2024 Active Research Limited. All rights reserved. www.actisense.com' and 'Firmware Version 1.329, Web Version 1.076'.

Note: If the password is forgotten, it can be reset back to the default after gaining physical access to the unit. See Password Recovery.

The Access Point can be set to "Hidden" in which case the SSID will not be broadcasted. If it is set to "Hidden", you will need to use the "join hidden network" function on your PC or device in order to connect to the WGX-1-ISO. The SSID of the WGX-1-ISO will then need to be manually typed in when prompted.

The authentication mode can be set by "Authmode". By default this is "WPA2-PSK", which is supported by most modern PCs and devices.

Warning: It is NOT recommended to set this to "Open" as this will allow any Wi-Fi enabled PC or mobile device to access the WGX-1-ISO without entering a password.

The Access Point uses Wi-Fi channel 1 by default, however when a client is joined, the Wi-Fi channel of the client will be adopted for all modes. If a user is connected to the WGX-1-ISO Access Point and then joins a Client network, the link to the Access Point will be dropped if the Client network is set to a different Wi-Fi channel. In this case, simply reconnect to the Wi-Fi Access Point if needed, and your PC or device will adopt the correct Wi-Fi channel.

The maximum number of simultaneous connections to the Access Point is 4.

Wi-Fi Client Settings

This page allows the user to scan for Client networks and then either join or disconnect from these networks.

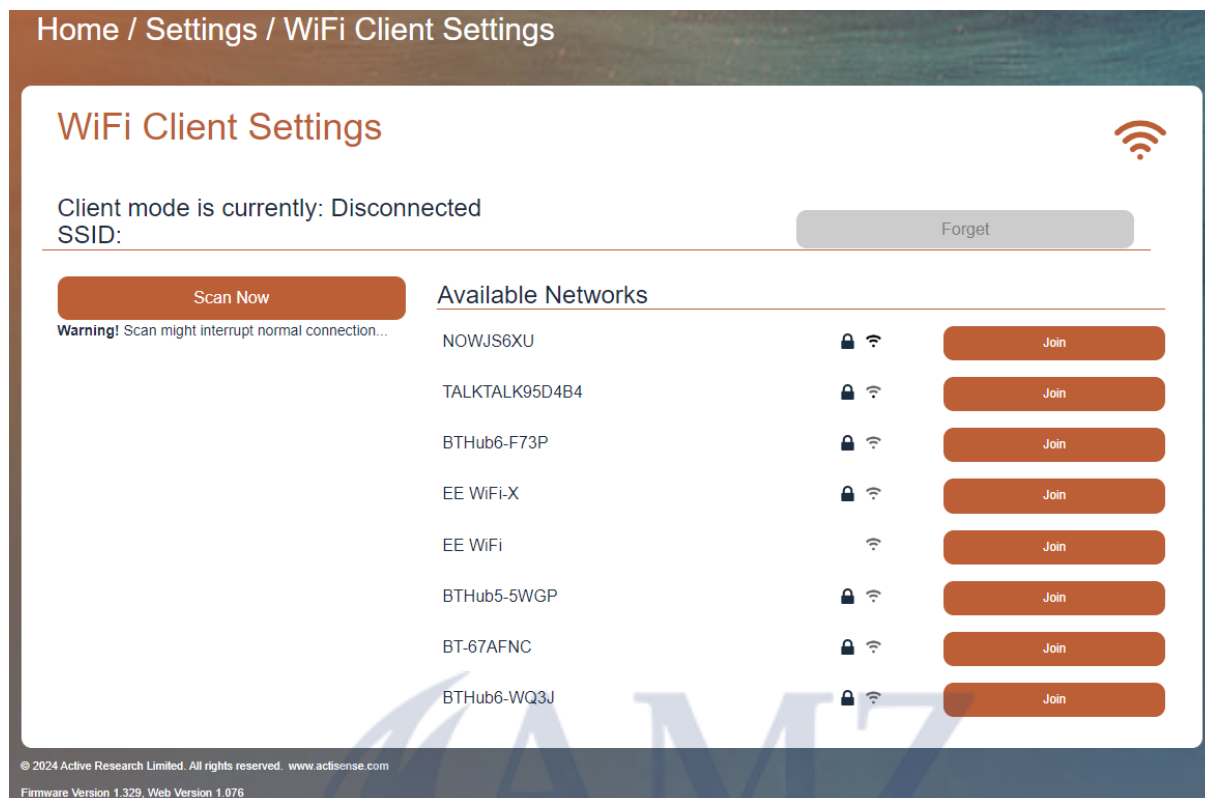

Note: The connection will be interrupted during a scan.

This page shows the current connection status and Client SSID (if connected) in the top status bar.

When a Client network is joined, the Wi-Fi channel of the Client will be adopted for all modes. The WGX-1-ISO will be issued with an IP address by the Client network, and this IP address should then be used to connect to and access the WGX-1-ISO via the Client network.

The WGX-1-ISO Access Point will still be active and you can find out the IP address allocated to the WGX-1-ISO by connecting to the Access Point and entering the default **IP address 192.168.4.1** in a web-browser and checking the Information Page.

Note: The WGX-1-ISO remembers the Client's connection details and will use those to automatically join the Client after a power cycle, or when the connection is dropped for some reason. Click the "Forget" button to remove a client's connection details from the WGX-1-ISO's memory.

Operating Mode Settings

The devices Operating mode can be changed here.

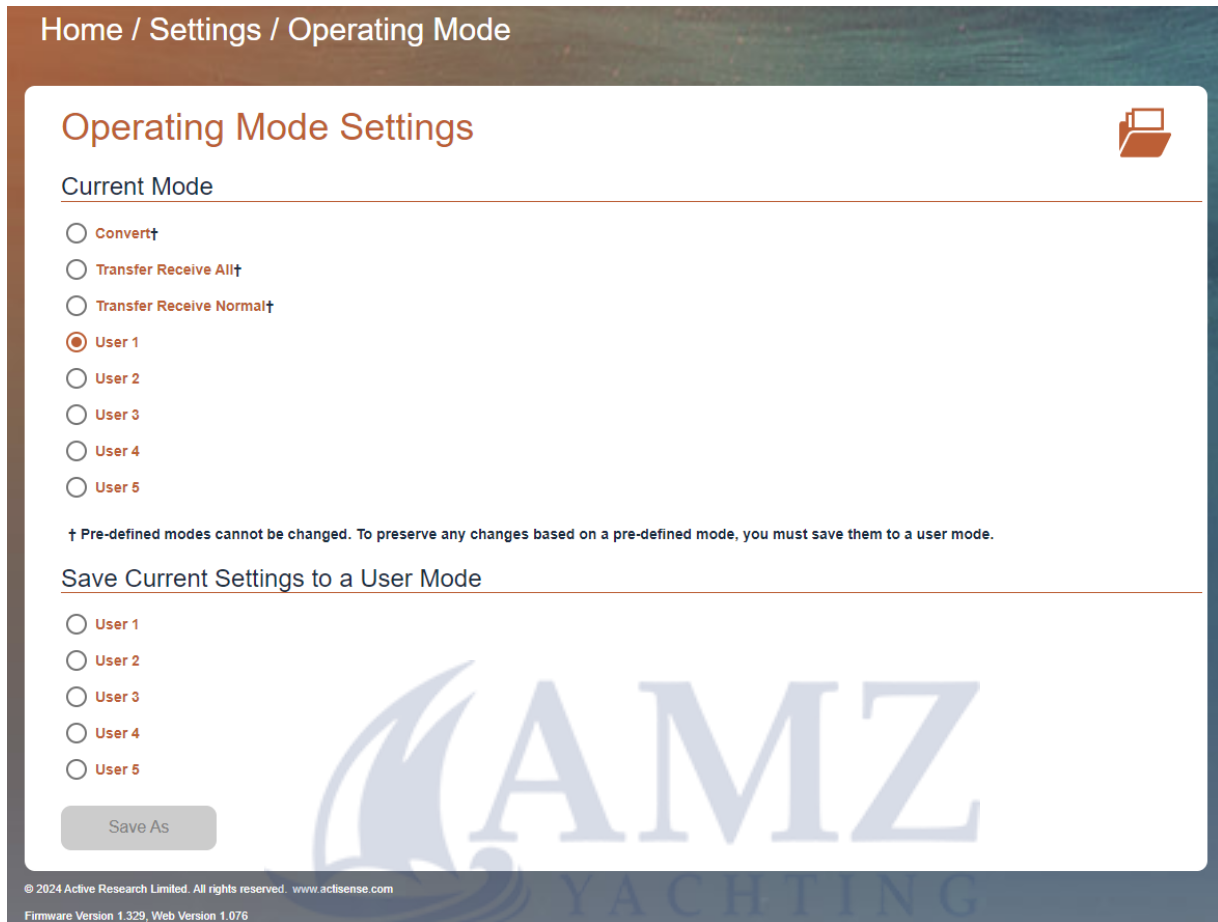

Convert mode replicates the operation of the legacy NGW-1 for backward compatibility. This allows for bi-directional conversion of NMEA 2000 messages to NMEA 0183 sentences.

Transfer Receive All and **Transfer Receive Normal** replicate the operation of the legacy NGT-1 for backward compatibility. This allows for Transfer of NMEA 2000 messages to a compatible PC application.

The device has **5 User modes** which can be independently configured using the Routing Settings and Serial Settings pages

Note: By default (factory default) the device will start up in **Convert mode**, making it compatible with the Actisense NGX-1. However, if the device has been set to a different mode using this page then it will save this mode as its startup mode and it will always start up in this mode.

Data Server Settings

This allows the user to configure the IP connection of the Data Servers.

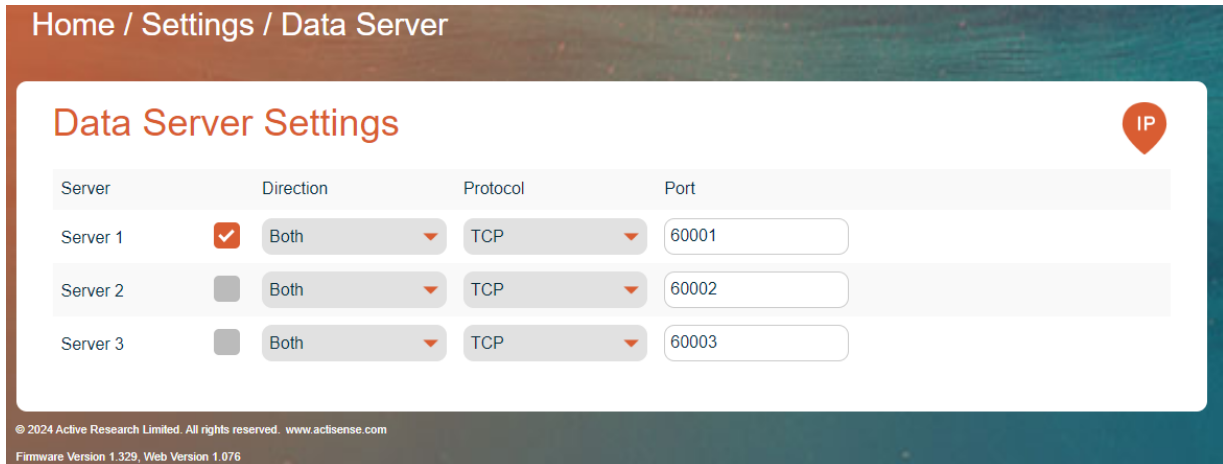

The WGX-1-ISO has three separate data servers – “Server 1”, “Server 2” and “Server 3” which can work concurrently and can be enabled independently. The Data Server Settings need to be configured to correspond to that of the connected application software. To configure a data server for your application, you can setup the “Protocol”, “Direction” and “Port”. There is also an independent “Check box” which can enable or disable a data server. This will not cause the WGX-1-ISO to forget the other settings – it is an on/off switch which will start or stop that server.

Note: The Format and baud rate of the data is set on the Serial settings page.

Protocol

This is the “IP” protocol used. Both TCP and UDP are supported, and this should be set according to the connected applications’ capabilities. TCP is recommended as it has built-in error correction.

Note: If a client network has been joined, then UDP will be available via both client network and Access point because UDP connections only require a Port Number.

Direction

This sets whether this data server will transmit, receive, or both receive and transmit data.

Port

By default, the WGX-1-ISO uses Ports 60001 - 60003, but can be set to any value corresponding to that of the application software. IP Ports can be set in the range 1-65535, although ports 1-1024 should be avoided, as they are used by special internet services. Setting a data server to use those ports could result in network problems.

Note: Some applications use the default setting for NMEA 0183 over Wi-Fi as port 10110, so in this case the WGX-1-ISO data server settings should be set to 10110. Other vendors such as Navionics use port 2000 for the default NMEA Wi-Fi gateway.

To get an application to work with the WGX-1-ISO, the IP Address of the WGX-1-ISO (see Wi-Fi Access Point and Client Settings) and the port settings need to correspond. For UDP, often only the port number is used, and it is possible to merge data across multiple applications by sending to the same UDP port. Thus, care should be exercised, as not all data formats are compatible.

Serial Settings

The Serial settings page allows the user to configure the different Serial interfaces. (i.e. Serial (ISO) port and Wi-Fi Data Servers)

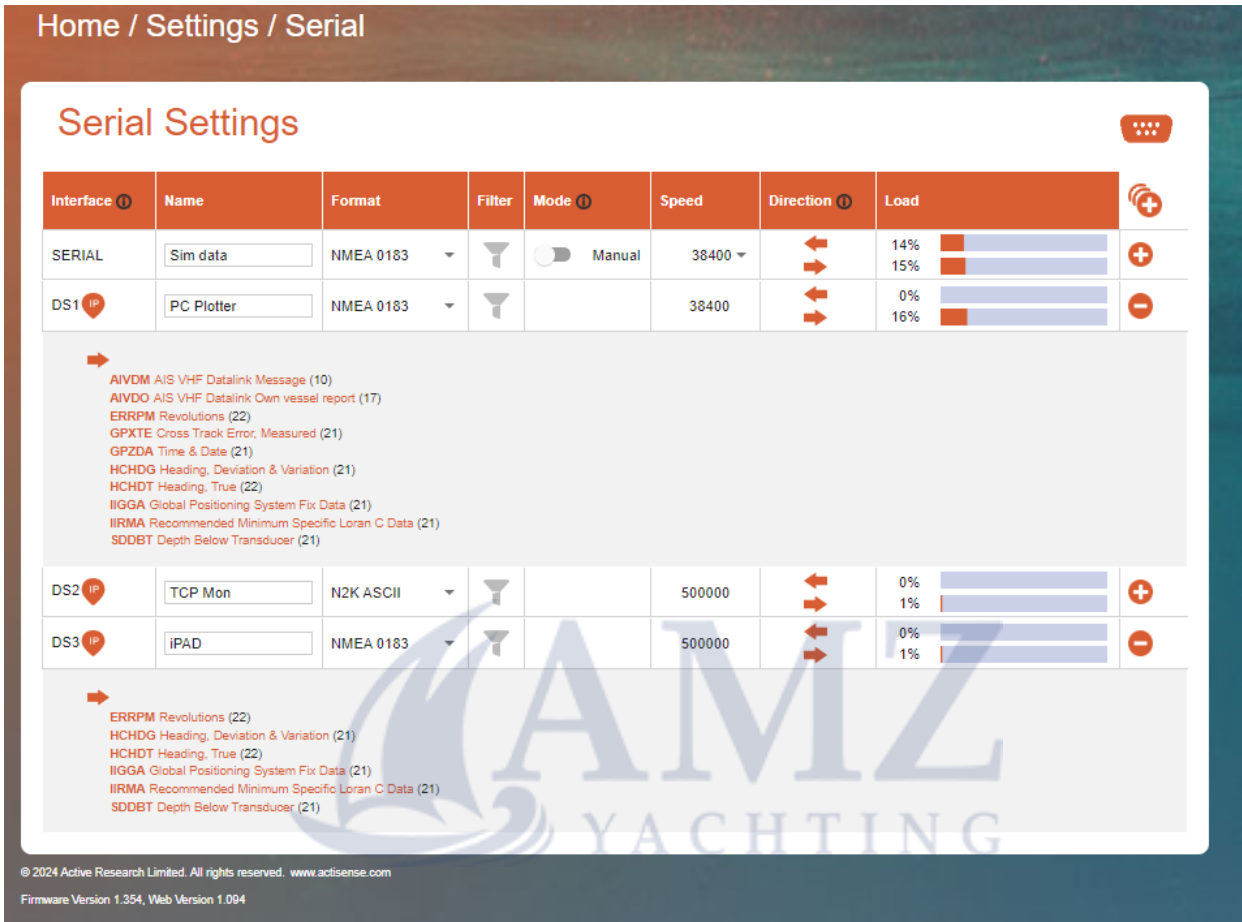

You can add a friendly name for the interface, configure the format, add filters, configure baud rates (and set Manual / Auto baud)

It also provides a useful indication of the current loading of the interfaces. Clicking on the “+” will provide details of the sentences / PGN’s which are being sent / received along with the number of times detected during the previous 10 seconds in brackets.

Name

A friendly name of up to 10 characters can be added to help identify the interface.

Format

This selects the format of the data which is Sent on the interface and several data formats are provided. If the format required for your application is not currently available, please contact Actisense support to check availability – we might already have it on our development road map or be able to add it specifically for a customer application. The current formats are:

NMEA 0183

As most applications support the NMEA 0183 format, this provides universal compatibility, however please note that this involves conversion from NMEA 2000 PGNs to NMEA 0183 sentences and not every NMEA

2000 PGN field has a corresponding NMEA 0183 sentence field. Conversions for all popular sentences and PGNs are provided, please refer to the current WGX-1-ISO Conversion List.

ASCII RAW

This allows the WGX-1-ISO to send and receive raw CAN packets to and from the NMEA 2000 bus. Caution should be exercised when sending unformatted CAN data to the NMEA 2000 bus. It is supported by some other manufacturers as a means for receiving and sending CAN information in its simplest “Raw” form. ASCII Raw has the advantage of being human readable.

Actisense RAW

Like ASCII raw, this format allows the WGX-1-ISO to send and receive raw CAN packets to and from the NMEA 2000 bus. Similar caution should be exercised as for ASCII Raw when sending unformatted CAN data to the NMEA 2000 bus. This format is not currently widely supported and will be used by Actisense data logging and simulation technology in due course. For user applications, this format is more bandwidth efficient than ASCII formats and will be fully documented for use by third party software.

ASCII N2K

This is a new Actisense proprietary encoding technique for transferring complete NMEA 2000 PGNs. This format can be sent and received by the WGX-1-ISO. If viewed on “IP port monitor” software such as <https://www.aggsoft.com/serial-port-monitor.htm>, the N2K “PGNs” are easy to read as a scrolling text display. The advantage of this format is that all PGN data is “assembled” from the raw CAN packets into an easier to use format for user applications. This format will be fully published on the Actisense website.

Actisense N2K

For transferring complete NMEA 2000 PGNs. This format can be transmitted and received by the WGX-1-ISO. This is a pure binary format used by the future versions of Actisense Toolkit software to allow data logging and analysis of N2K data. It is more bandwidth efficient than ASCII N2K format. This format will be fully published on the Actisense website.

Actisense NGT

This format has been in use by the Actisense NGT-1 since 2007. Currently this format can only be transmitted from the WGX-1-ISO. This is also a pure binary format encoded in the same binary format as the Actisense NGT. For software applications that have been previously designed to be compatible with the NGT-1, this format will work directly with that software. There are third-party applications which can use this NMEA 2000 binary format now.

Filtering

The filter option allows for fine tuning of the data which is sent and received on each interface. This is useful for limiting bandwidth.

Clicking the Filter Icon will open a list containing check boxes which can be selected for both Sentences and PGN's. (Selectable with toggle switch in top right corner)

Note: The WGX-1-ISO always receives both Sentences and PGN's on each interface, but will only send according to the format selected above.

A useful search option is provided to aid finding desired data.

Once configured, click “Save” to apply your settings.

Filter for interface : SERIAL

Rx Select all Tx Select all

Rx Deselect all Tx Deselect all

PGNs Sentences

Search

Sentence (193)	Rx (188)	Tx (188)
AAM Waypoint Arrival Alarm	<input type="checkbox"/>	<input type="checkbox"/>
ABK AIS Addressed and binary broadcast acknowledgement	<input checked="" type="checkbox"/>	<input checked="" type="checkbox"/>
ABM AIS Addressed binary and safety related message	<input checked="" type="checkbox"/>	<input checked="" type="checkbox"/>
ACA AIS Regional Channel Assignment Message	<input checked="" type="checkbox"/>	<input type="checkbox"/>
ACF General AtoN Station Configuration Command	<input checked="" type="checkbox"/>	<input type="checkbox"/>
ACG Extended General AtoN Station Configuration Command	<input checked="" type="checkbox"/>	<input type="checkbox"/>
ACK Acknowledge Alarm	<input type="checkbox"/>	<input checked="" type="checkbox"/>
ACM AIS Base Station Addressed Channel Management Command	<input checked="" type="checkbox"/>	<input checked="" type="checkbox"/>
ACS AIS Channel management information Source	<input checked="" type="checkbox"/>	<input type="checkbox"/>
ADS Automatic Device Status	<input checked="" type="checkbox"/>	<input checked="" type="checkbox"/>
AFB AtoN Forced Broadcast Command	<input checked="" type="checkbox"/>	<input checked="" type="checkbox"/>
AGA AIS Base Station Broadcast of a Group Assignment Command	<input checked="" type="checkbox"/>	<input checked="" type="checkbox"/>
AID AtoN Identification Configuration Command	<input checked="" type="checkbox"/>	<input checked="" type="checkbox"/>
AIR AIS Interrogation Request	<input checked="" type="checkbox"/>	<input checked="" type="checkbox"/>
AKD Acknowledge Detail Alarm Condition	<input type="checkbox"/>	<input checked="" type="checkbox"/>
ALA Set Detail Alarm Condition	<input type="checkbox"/>	<input checked="" type="checkbox"/>
ALM GPS Almanac Data	<input type="checkbox"/>	<input checked="" type="checkbox"/>
AID	<input checked="" type="checkbox"/>	<input checked="" type="checkbox"/>

Cancel Save



Mode / Speed

The mode of the serial port can be set to either Auto baud or else to use a manual baud rate. Set the Speed to be that of the device to which you are connecting the WGX-1-ISO. Manual baud rates are usually preferred if the baud rate is known and there is no chance of it changing. If connecting to a PC use the highest baud rate to ensure that no data will be lost.

Routing Settings

The WGX-1-ISO is a powerful routing device and this page allows this routing to be configured. The device can be set up quickly by using “Basic” routing which will route **all** data from a Source to a Destination on a selected route. In the matrix simply select which source should be routed to which destination. An arrow symbol will show a route (i.e. all data will be passed) whereas a blank indicates there is no route. (i.e. all data will be blocked)

In the example below

All data from the Serial Port will be routed to the NMEA 2000 (N2K) Port, DS1, DS2 and DS3.

All data from the NMEA 2000 port (N2K) will be routed to the Serial Port, DS1 and DS3.

All data from DS1 will be routed to the Serial Port and the NMEA 2000 (N2K) Port.

All data from DS3 will be routed to DS1.

Basic Routing

Home / Settings / Routing

Routing Settings

The matrix shows routes between both **real** and **virtual** interfaces.
▲ Basic routing can be overridden by Advanced Routing rules.

Source	Destination	SERIAL-Sim data NMEA 0183	N2KV1	DS1-PC Plotter NMEA 0183	DS2-TCP Mon N2K ASCII	DS3-IPAD NMEA 0183	
SERIAL-Sim data			↑	↑	↑	↑	+
N2K		↑		↑		↑	+
DS1-PC Plotter		↑	↑				+
DS2-TCP Mon							+
DS3-IPAD				↑			+

© 2024 Active Research Limited. All rights reserved. www.actisense.com
Firmware Version 1.354, Web Version 1.094

The WGX-1-ISO allows for “Advanced” routing by clicking the “+” on the right hand side of the source row. This allows for fine tuning of which data is passed or blocked.

This is done by creating a routing rule which can be input manually or else use the suggested rules which are presented. These rules are automatically populated from the data which the WGX-1-ISO is currently seeing on that particular interface. For a rule to be activated it needs to be enabled with the toggle switch on the right hand side.

When an advanced rule is enabled you essentially modify the functionality of the “Basic” rule above. A blue triangle appears to indicate that an advanced rule is being applied. The details of that rule can be seen next to each enabled rule.

In the example below the rule for “HCHDT” (an auto populated sentence which the WGX-1-ISO detected being received on the Serial interface) has been enabled.

The Route for HCHDT to DS3 was modified. (Clicking the route removed it and it now shows Blank indicating no route)

A Blue Triangle appears on the Route above indicating that an “Advanced” Route is applied.

This modified route w.r.t. the Serial interface is as follows:

All data from the Serial Port will be routed to the NMEA 2000 (N2K) Port, DS1 and DS2.

All data except for “HCHDT” from the Serial Port will be routed to DS3.
This is shown below:

Advanced Routing

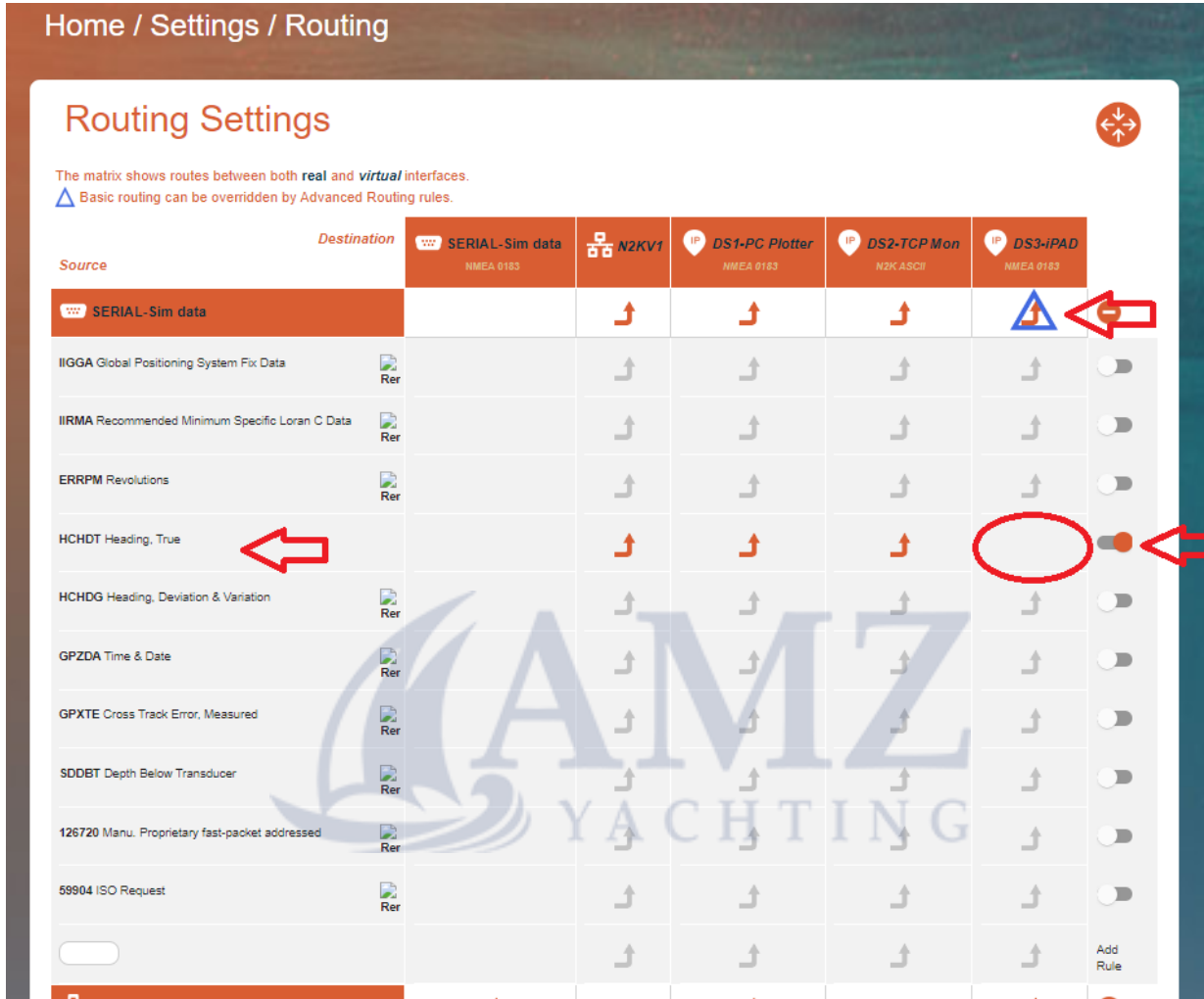

In the example below a rule for HCHDG was manually entered and then enabled. It was modified by clicking on a route from DS3 to the Serial port. **Note:** There was no existing route covering this, i.e. it was blank. A Blue Triangle appears on the Route above indicating that an “Advanced” Route is applied. This modified route w.r.t. the DS3 interface is as follows:
All data from DS3 is routed to DS1.
Only “HCHDG” from DS3 is routed to the Serial Port.
This is shown below:

Advanced Routing

Home / Settings / Routing

Routing Settings

The matrix shows routes between both **real** and **virtual** interfaces.
▲ Basic routing can be overridden by Advanced Routing rules.

Source	Destination	SERIAL-Sim data NMEA 0183	N2KV1	DS1-PC Plotter NMEA 0183	DS2-TCP Mon N2K ASCII	DS3-iPAD NMEA 0183	
SERIAL-Sim data			↑	↑	↑	▲	+
N2K		↑		↑		↑	+
DS1-PC Plotter		↑	↑				+
DS2-TCP Mon							+
DS3-iPAD		▲		↑			-
HCHDG Heading, Deviation & Variation		↑		↑			+
				↑			

© 2024 Active Research Limited. All rights reserved. www.actisense.com
Firmware Version 1.354, Web Version 1.094

NMEA 2000 Settings

This allows the configuration of Preferred NMEA 2000 Addresses along with configuration of filter lists for PGN's transmitted and received on the NMEA 2000 interface.

The NMEA 2000 interface has two virtual devices: a core device as well as a virtual data device. The Battery Status can also be configured and corresponding instance can be set.

Filtering

The core device filter list can be used to configure PGN's received whilst the Data1 device for those transmitted.

The transmitted PGN's can have the default Tx rate adjusted by clicking on the corresponding rate. Once configured, click "Save" to apply your settings.

Logging Settings

This allows the enabling of logging and provides the ability to format the micro SD card. It also provides a useful graphic showing how much space is available on the micro SD card.

The screenshot shows the 'Logging Settings' page. At the top, it says 'Home / Settings / Logging'. The main heading is 'Logging Settings' with a 'LOG' icon. Below this, 'Enable Logging' is checked with a red checkmark. 'SD Card is present' is shown in green text. A red button labeled 'Format SD Card' is next to a warning: 'Warning: Formatting will delete all log files.' Below this is a section for 'SD Card Space' with a pie chart. The text next to the chart indicates: 'Used: 2.3 GB', 'Free: 1.4 GB', and 'Total: 3.7 GB'. The pie chart is divided into an orange section for 'Used' and a grey section for 'Free'. At the bottom, there is a copyright notice: '© 2024 Active Research Limited. All rights reserved. www.actisense.com' and 'Firmware Version 1.354, Web Version 1.094'.

Administration Settings

The Admin (Login) password can be changed here to a new one that's between 2 and 30 characters long. If the password is mislaid or forgotten, it can be reset back to the default after gaining physical access to the device and pressing the re-set button. See Password Recovery.

Note: The default Username is set to "admin" and the default password is set to the default admin password printed on the rear of the unit. This is unique for every device but we recommend that this is changed to reduce the chance of unauthorised access to the N2K network and the vessels systems.

The screenshot shows the 'Administration' page. At the top, it says 'Home / Settings / Administration'. The main heading is 'Administration' with a gear icon. Below this is a section for 'Change Administrator Password'. It includes a 'Username' field with the value 'admin'. There are two password fields: 'New Password' and 'Re-type New Password', both with eye icons for visibility. A red 'Update' button is at the bottom. At the bottom, there is a copyright notice: '© 2024 Active Research Limited. All rights reserved. www.actisense.com' and 'Firmware Version 1.329, Web Version 1.076'.

Firmware Update Page

This page allows the device to update its firmware by selecting the corresponding firmware file with the file selection dialog. This firmware .zip file will need to be downloaded from the www.actisense.com website and stored on the PC/device to allow it to be selected.

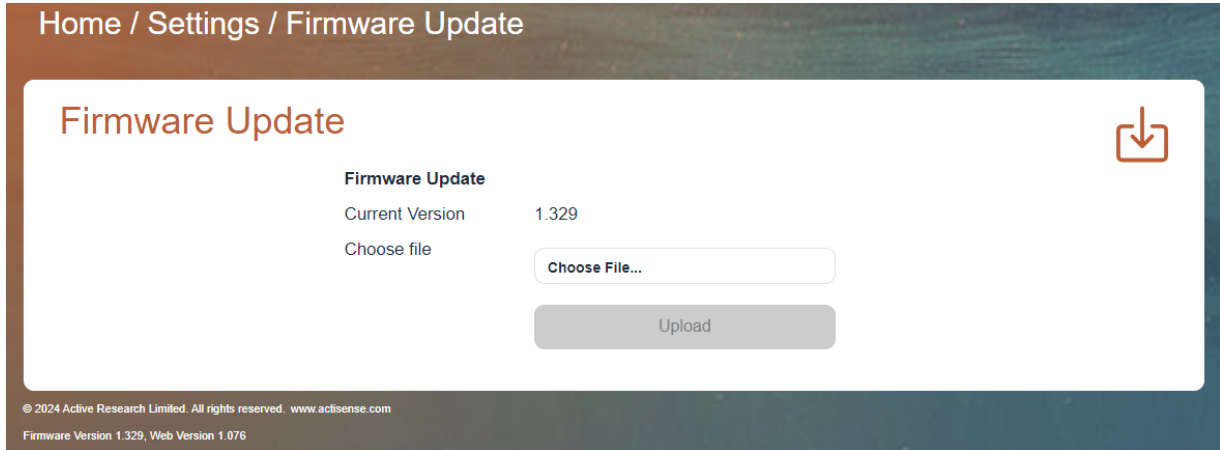

Note: see the Firmware Update section below for **Important Information** and different methods to update the devices firmware.

Reset Device

This allows the user to restore the WGX-1-ISO to it's Default factory settings. It also allows the user to restart the device should this be required.

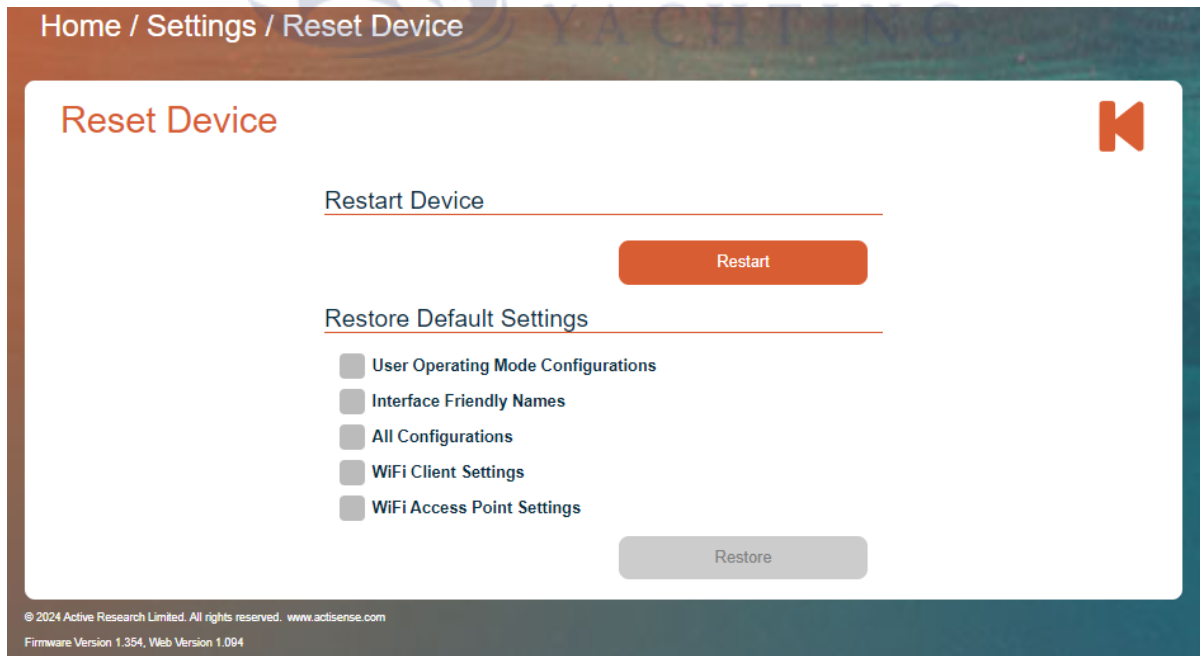

Actisense-i

Actisense-i brings valuable diagnostic capabilities to your WGX-1-ISO. Monitor various facets of your NMEA 2000 network through a neat graphic interface. Actisense will be adding new functionality regularly through firmware updates. Stay updated via our blog and social media channels. More information about Actisense-i can be found at www.actisense.com/actisense-i.

Actisense-i

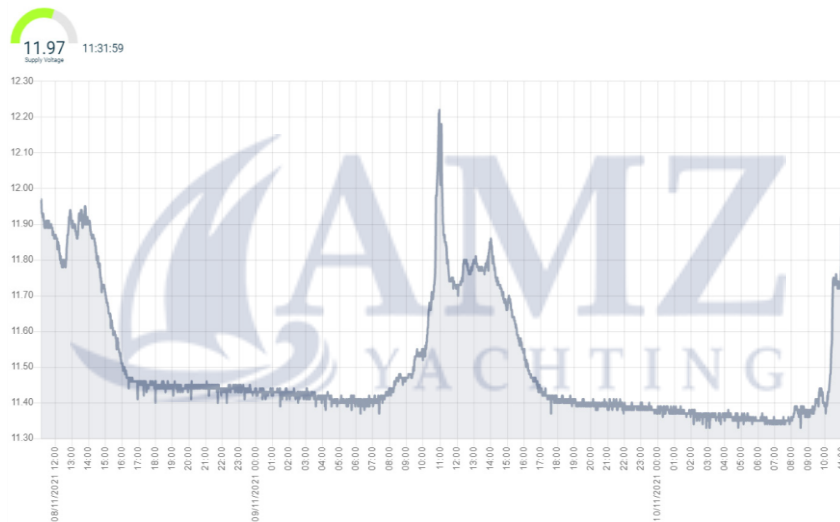

The Smart Timer sets a period between parameter value checks, if a change has been found that is greater than the Smart Threshold then the value is logged. The Maximum Timer sets a maximum period between logs. Once this period has elapsed the value is logged regardless of any change. The Maximum Timer is reset if the Smart Timer triggers a log.

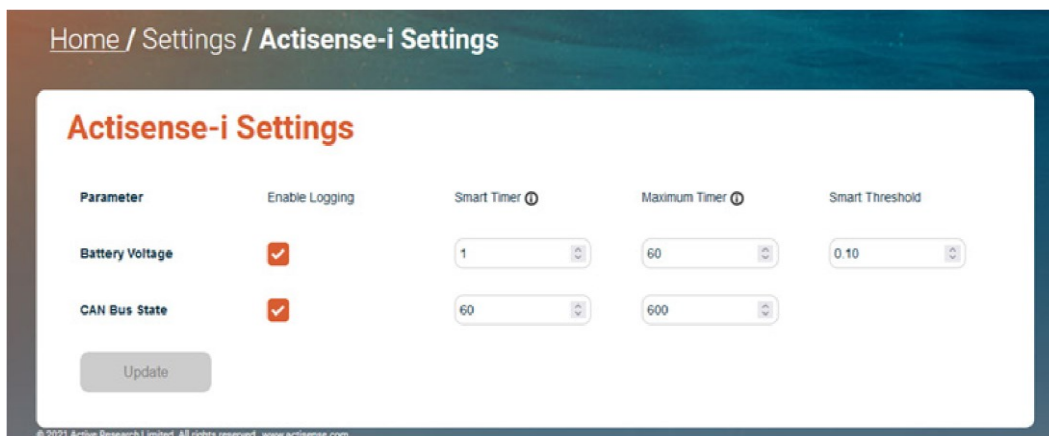

Alongside the battery monitoring capability, the WGX-1-ISO with Actisense-i will also provide you with a detailed breakdown of the complete NMEA 2000 network, including device name, source address, LEN and device info. This feature enables the user to dive deeper into the network, and acts as a high level diagnostic tool.

Parameter	Unit	Value
Total Load	LEN	7
Total Current	mA	350
Bus Voltage	V	15.07

© 2024 Active Research Limited. All rights reserved. www.actisense.com
Firmware Version 1.354, Web Version 1.094

A useful, detailed Network report can be created and exported to either a .pdf or .csv format for record keeping.

Home / Actisense-i / Network Report

Network Report

14:53 05/08/24

Export CSV Export PDF

Boat Name

Tested By

Save

Source	Manufacturer	NMEA Name	Device Function	Model Id	Serial Id	
4	Actisense	C03282002222B414	PC Gateway (130)	NMEA 2000 PC Interface (NGT-1)	177172	⊖
Manufacturer Code: 273 Device Class: Inter/Intranetwork Device(25) NMEA Database Version: 2.100 Product Code: 28199 Software Version: 1.100, 2.990 Load Equivalency: 1 (50mA)						
5	Actisense	C03282002224AEC	PC Gateway (130)	NMEA 2000 PC Interface (NGT-1)	281324	⊖
Manufacturer Code: 273 Device Class: Inter/Intranetwork Device(25) NMEA Database Version: 2.100 Product Code: 28199 Software Version: 1.100, 2.990 Load Equivalency: 1 (50mA)						
8	Actisense	C03287002223FBD4	NMEA 0183 Gateway (135)	NMEA 2000<->0183 Gateway (NGW-1)	261076	⊖
Manufacturer Code: 273 Device Class: Inter/Intranetwork Device(25) NMEA Database Version: 2.100 Product Code: 11369 Software Version: 1.100, 2.990 Load Equivalency: 1 (50mA)						
1	Actisense	C032890022200305	NMEA 2000 Wireless Gateway (137)	NMEA 2000 WiFi Gateway (WGX-1)	773	⊕
7	Actisense	C03289002223A0AB	NMEA 2000 Wireless Gateway (137)	NMEA 2000 Wi-Fi Gateway (W2K-1)	237739	⊕

LED Operation and Indication Trouble Shooting Guide

LED	Colour	Normal State	Description	User action (during abnormal state)
Power	Blue	Pulsing	Indicates presence of power	Check power on NMEA2000 Bus / Check Fuses / Battery Voltage
		Flashing Fast	Indicates Firmware Update (Approx 4 times per second)	Do not remove power while the Firmware update is in progress
Status	Green	Solid	Indicates Convert mode	Ensure the device is in the correct desired operating mode.
	Green	Flashing	Indicates User mode	
	Red	Solid	Indicates Transfer Receive Normal mode(NGT)	Ensure the device is in the correct desired operating mode.
	Red	Flashing	Indicates Transfer Receive All mode(NGT)	Ensure the device is in the correct desired operating mode.
NMEA2000 - RX	Green	Flashing	Indicates data is being received on the NMEA2000 bus	Confirm there is another device transmitting on the NMEA2000 bus. Check filter settings.
NMEA2000 - TX	Amber	Flashing	Indicates data is being transmitted on the NMEA2000 bus	Confirm there are at least two NMEA2000 devices present on the bus. Check filter settings.
NMEA0183 - RX	Green	Flashing	Indicates data is being received from the Serial port	Check filter settings. Check Baud rate in Serial settings.
NMEA0183 - TX	Amber	Flashing	Indicates data is being transmitted to the Serial port	Check filter settings. Check Baud rate in Serial settings.

First level WGX-1-ISO diagnostics / fault finding can be performed by observing the LED behaviour.

The normal behaviour of the WGX-1-ISO LEDs is described in the table above. If the LEDs are not behaving as expected, this will indicate a fault in either the device connected to the WGX-1-ISO, the NMEA 2000 network, or the WGX-1-ISO itself.

Some common checks to perform on the WGX-1-ISO if the correct LED behaviour is not displayed:

- Connectors are properly inserted and secure.
 - If NMEA 2000 field fit connectors are used, all pins have been wired correctly and wires are terminated firmly.
 - The NMEA 2000 network is properly terminated at each end, with a 120 ohm resistor. The network should not have more than two terminators. Make sure that any devices attached to the network do not contain any internal termination resistors.
 - If using a client network then UDP will only be available via the client network.
- Note:** Pulsing refers to the continuous “fading” mode of the LED.

Note: If the WGX-1-ISO does not re-direct to the home page and an error message is displayed, the likely cause is that the connection to the access point has been dropped during a re-start. This is dependant on the device connecting to the WGX-1-ISO’s connection settings, and is also dependant on the operating system. The device should be set to automatically connect to prevent this situation, thus avoiding having to manually re-connect.

Technical Support and the Returns Procedure

The first point of contact for all technical enquiries should be the vendor / supplier where the device was originally purchased. All warnings in this manual must be adhered to and installation instructions followed prior to any support requests. If the troubleshooting guide or the supplier are not able to help resolve the problem and an error persists, please visit the Actisense help centre at www.actisense.com/support where you will find useful articles to aid further troubleshooting in our FAQ's and Knowledge Base.

You will also find a link to the support centre where you can register and raise a support ticket.

If, after investigation we conclude that the WGX-1-ISO unit should be returned to Actisense, a 'Return to Merchandise Authorisation' (RMA) number will be issued.

The RMA number must be clearly visible on both the external packaging and any documentation returned with the product. Any returns sent without an RMA Number will incur a delay in being processed and a possible charge. Any cables originally supplied with the product are to be included in the returned box.

Inserting a micro SD card

The WGX-1-ISO allows a micro SD card to be inserted for logging of data and updating the devices firmware.

Warning: Before doing this ensure the device is disconnected from the NMEA 2000 network and power! It is important to observe ESD precautions when handling the PCB to avoid static damage!

On the ISO / Serial side of the WGX-1-ISO housing carefully remove the two screws using a PZ1 (pozi) screwdriver. Then carefully remove the end-cap and locate the micro SD card holder. Insert the micro SD card into the card slot with the contacts facing the PCB.

Note: the card holder is a push-push type mechanism. (i.e. push to lock, push again to release)

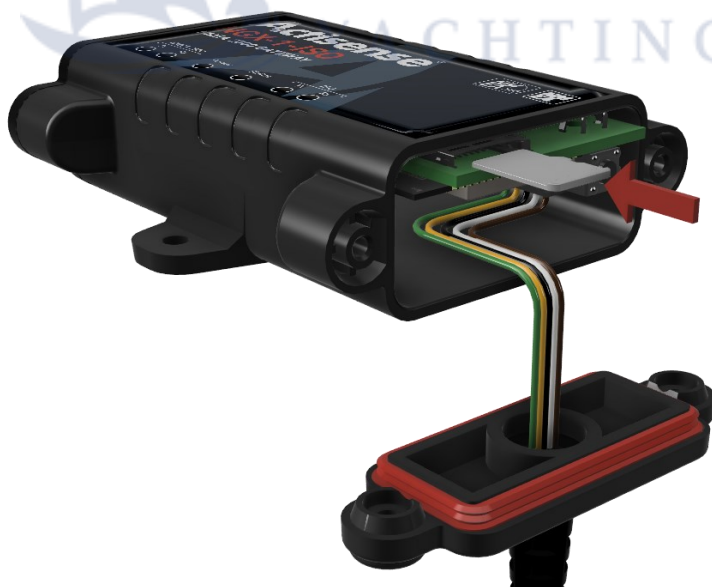

Replace the end-cap into position making sure that the waterproof gasket seals correctly. Fix the device closed with the two screws.

SD card requirements

The WGX-1-ISO supports microSD, microSDHC , microSDXC cards with a minimum speed class C10.

We recommend a good quality Industrial or High-endurance card to ensure reliability. Recommended Maximum size is 128GB.

The length of time before the SD card becomes full depends on the amount of data on the NMEA 2000 network. When the SD card is full, it will begin to write over existing log files, starting with the oldest.

The amount of data which can be logged is dependant on exactly how “busy” the bus is. On a “busy” bus, (approximately 50% loading), the user can expect at least 12 days of continuous data logging on a 16GB card. On a “lightly loaded” bus, (approximately 5% loading), the user can expect in excess of 60 days continuous data logging on a 16GB card.

If the WGX-1-ISO is restarted or power cycled, it will create a new log file and the previous log file size will be dependant on when restart occurred.

Password Recovery

It is not possible to reset the Wi-Fi and / or admin username and password using the NMEA 2000 connection as this would require an insecure transmission of the Wi-Fi password, therefore for additional security, the method used to reset the password to its defaults requires physical access to the unit and is provided via a reset button mounted on the PCB. Please follow the procedure below to re-set your device.

Warning: Before doing this ensure the device is disconnected from the NMEA 2000 network and power! It is important to observe ESD precautions when handling the PCB to avoid static damage!

On the ISO / Serial side of the WGX-1-ISO housing carefully remove the two screws using a PZ1 (pozi) screwdriver. Then carefully remove the end-cap and locate the small push button on the PCB edge.

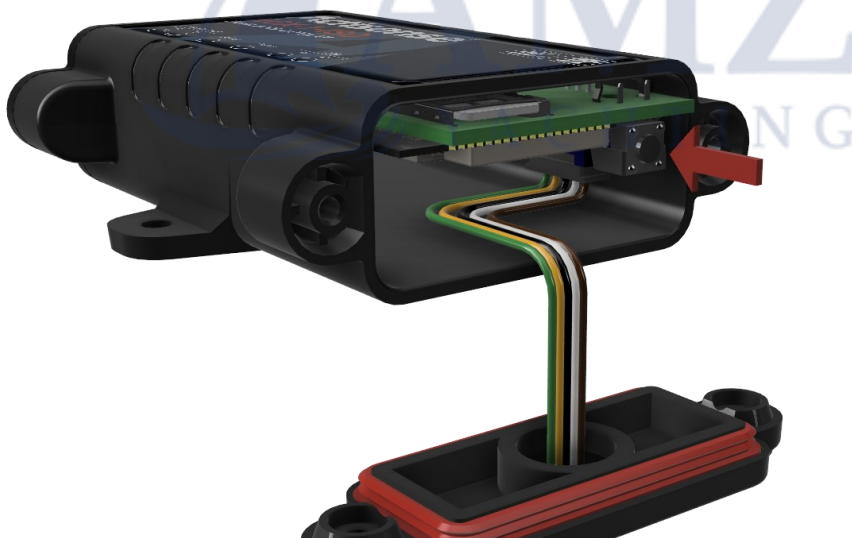

Carefully power the device up ensuring that there is no chance of anything touching the PCB which could cause shorts and damage the device. Depress the pushbutton for **5 seconds**, then release it. The device should restart after a further 5 seconds with the passwords reset to default.

The Wi-Fi password will be reset to the default password which is printed on the label on the underside of the unit.

The Admin username and password will also be reset back to their factory defaults which is printed on the label on the underside of the unit.

Firmware Update

The WGX-1-ISO allows its firmware to be updated ensuring the user always has the latest features.

The latest firmware file can be found at www.actisense.com/products

Download the new firmware “.zip” file.

Note: Do NOT extract files prior to upload to the WGX-1-ISO as the complete .zip file needs to be uploaded.

The version of firmware currently installed in the WGX-1-ISO can be found in the “Information” menu on the WGX-1-ISO home page.

Warning: Do NOT disconnect the unit from the NMEA 2000 bus or remove power until the firmware update process has completed completely!

Note: The Blue PWR LED will flash fast indicating FW update is in progress. Please note that the device will continue to process the file once the update has completed.

Please **wait for the device to reset and for the Blue PWR LED to return to its normal pulsing state** which indicates the update process is complete. This can take several minutes. See LED Behaviour for further details.

Remember, you will need to re-connect to the device via Wi-Fi after the firmware upgrade once the device has restarted.

Firmware Update from WebApp via Wi-Fi

This is the easiest and fastest way to update the devices Firmware.

Go to the Firmware update option in the settings menu and choose the .zip firmware file to upload from your PC using the file selection dialog.

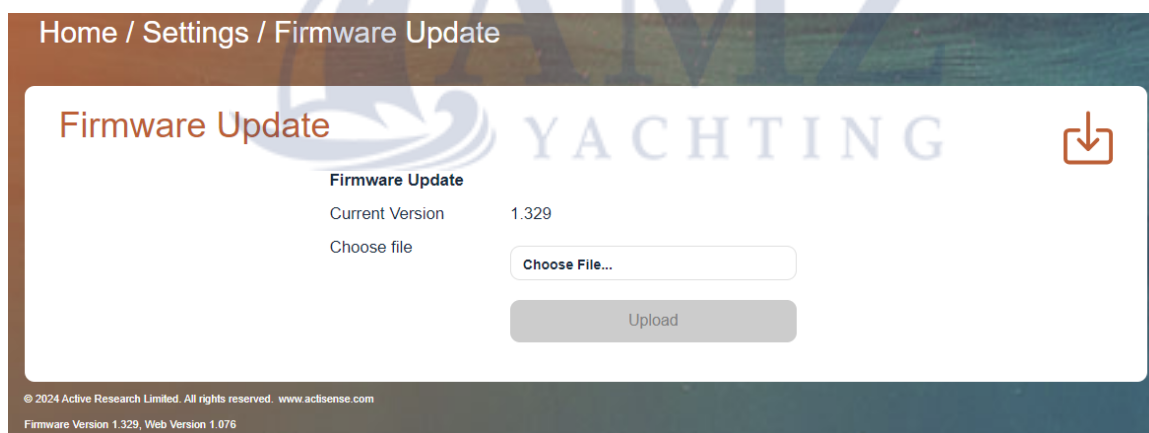

The WGX-1-ISO Blue PWR LED will flash fast indicating FW update is in progress,

Warning: Please wait for the device to reset and for the Blue PWR LED to return to its normal pulsing state which indicates the update process is complete to prevent damaging the device. This may take a few minutes!

Firmware Update using Actisense Toolkit

Toolkit can be used to update the Firmware via the Serial port or the NMEA 2000 bus using a compatible Actisense NMEA 2000 product. (e.g. NGT-1 or NGX-1) We recommend that the baud rate is set to at least 115,200. (preferably 230,400)

Select the WGX-1-ISO from the list of devices in Toolkit and then select the Upgrade Firmware option from the Ribbon menu.

Select the file and click on “program” to proceed with the firmware update.

Warning: Please wait for the device to reset and for the Blue PWR LED to return to its normal pulsing state

which indicates the update process is complete to prevent damaging the device. This may take a few minutes!

Firmware Update using micro SD card

The devices firmware can also be updated using a micro SD card.

Create a folder called “update” on the micro SD card and copy the “.zip” firmware file into this folder.

Please see Inserting a micro SD Card for details.

Once the WGX-1-ISO is powered up it will automatically start the firmware update process if it finds a recognised .zip file in the “update” folder.

The blue “power” LED will flash rapidly while the update process is in progress and, once updated, the .zip file will be automatically deleted from the SD card to prevent a repeated update on next power up.

Warning: Please wait for the device to reset and for the Blue PWR LED to return to its normal pulsing state which indicates the update process is complete to prevent damaging the device. This may take a few minutes!

Mounting the WGX-1-ISO

The WGX-1-ISO has an internal antenna which is located towards the top right hand side of the device and should not be mounted on a metal surface. To ensure best range it should be mounted horizontally and located centrally on the boat as high as possible, with the antenna towards the top and avoiding other metallic objects.

Warning: The WGX-1-ISO should not be mounted within 5m of a compass or operated within 20cm of a human body. To avoid potential injury it should be mounted at a height of less than 2m from floor level.

Bulkhead Mounting

The WGX-1-ISO can be secured to a bulkhead using the two screw holes either side of the WGX-1-ISO shown in the picture below.



Technical Specification

Power Supply	
Supply Voltage (NMEA 2000 Port)	9 to 30V DC
Supply Current (NMEA 2000 Port)	78mA @ 9V DC, Max 220mA
Load Equivalent Number (LEN)	2
NMEA 2000 Port	
Speed / Baud Rate	250kbps
Connectivity	M12 Male (A coded)
ISO Port	
Compatibility	Full NMEA 0183, RS232 & RS422 compatible. RS485 Listener compatible
Speed/Baud Rate	4800 to 230400 Baud
Output Voltage Drive	>= 2.1V (differential) into 100Ω
Output Current Drive	20mA max.
Output Protection	Short circuit and ESD
Input Voltage Tolerance	-15V to +15V continuous -35V to +35V short term (< 1 second)
Input Protection	Current limited and overdrive protection to 40VDC
Connectivity	5mm stripped and tinned wire
Cable Length	0.75m
Isolation	
NMEA 2000 Port to ISO Port	Uses IsoDrive™, Hi-Pot tested to 1000V
Wi-Fi Radio	
Compatibility	IEEE 802.11 b/g/n
Speed	802.11n up to 150Mbps
Frequency Band	Wi-Fi: 2412 -2484MHz
Max Output power	Wi-Fi: 19.14dBm (802.11b) 19.22dBm (802.11g) 19.12dBm (802.11n)
Antenna	Integrated internal antenna, 3.4dBi
Range (Open space)	approx. 30 meters
Security	WPA PSK, WPA2 PSK, WPA WPA2 PSK
Configuration	
IP support	Supports TCP & UDP broadcast
Data protocols	NMEA 0183 & Five proprietary
Security	Unique SSID and unique default Password per device. (Password is user configurable)
Mechanical	
Housing Material Body	Flame retardant Polycarbonate
Housing Material End Caps	Flame retardant PBT
Weight	112g
Dimensions	126mm x 73mm x 24mm
Approvals and Certifications	
NMEA 2000	NMEA 2000 Certified
NMEA 0183	IEC 61162-1 & 61162-2 compliant
RoHS and REACH	Compliant
Module Certification	KCC / BQB / IC / Wi-Fi / NCC / MIC / FCC DSS / FCC DTS / SRRC / CE
EMC	EN 60945:2002 Edition 4 (section 9.3) EN 301 489-1 V2.2.3 EN 301 489-17 V3.2.4 EN 300 328 V2.2.2 Radiated Spurious Emissions FCC Part 15b ICES-003 Iss 7
Environmental Protection	IP67
Operating Temperature	-25°C to +70°C
Storage Temperature	-30°C to +70°C
Recommended Humidity	0 to 93% RH @ 40°C
Guarantee	3 years, extended to 5 years upon registration

Product Dimensions (mm)

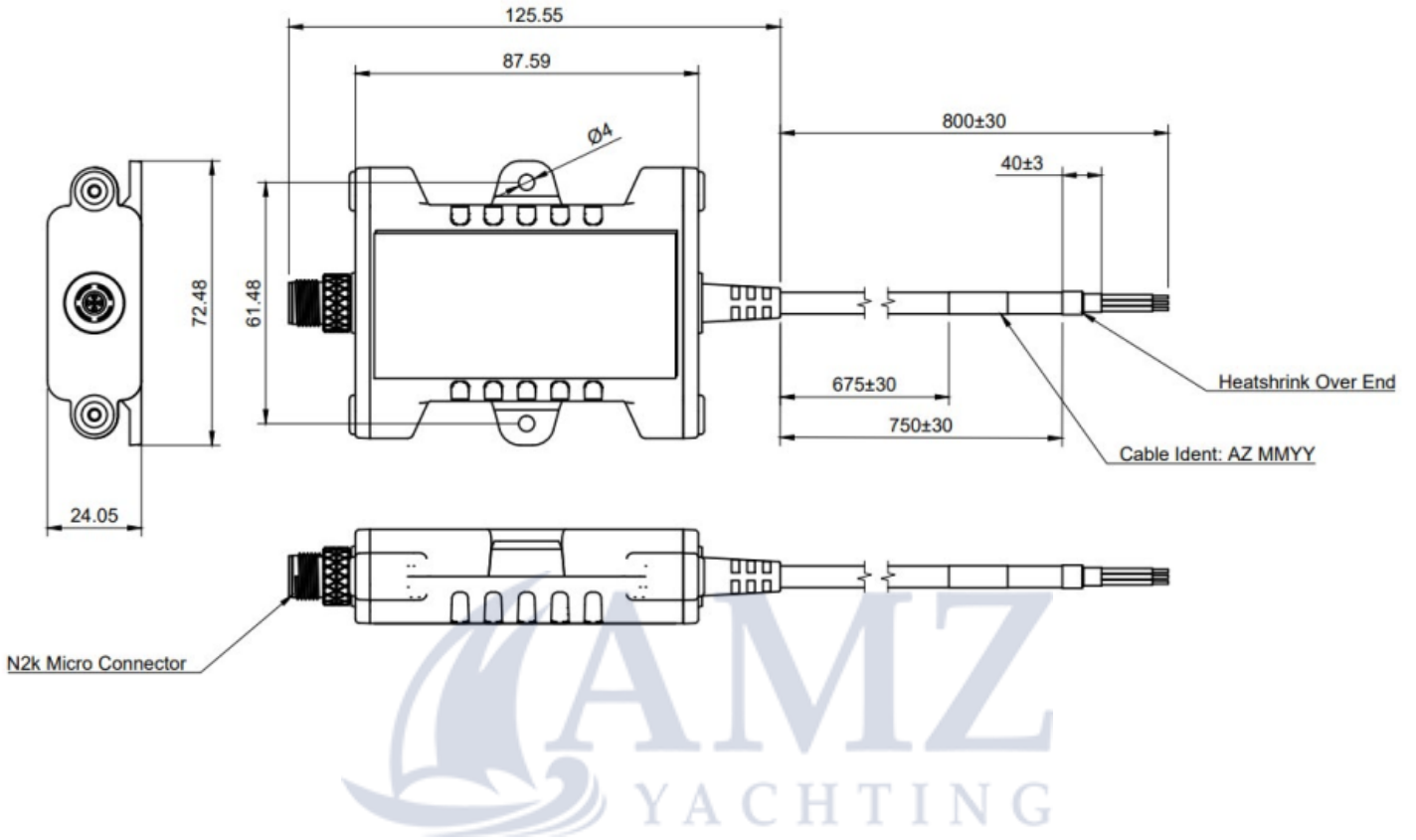

Actisense[®]

Connect without limits



Active Research Ltd
21 Harwell Road
Poole, Dorset
UK BH17 0GE

Email: sales@actisense.com

Web: www.actisense.com

Telephone: +44 (0)1202 746682